

EDH803BEWN



---

EN Tumble Dryer

---

User Manual



## CONTENTS

1. SAFETY INFORMATION.....	3
2. CONDITIONS OF USE.....	5
3. SAFETY INSTRUCTIONS.....	5
4. PRODUCT DESCRIPTION.....	7
5. CONTROL PANEL.....	8
6. PROGRAMME TABLE.....	9
7. OPTIONS.....	11
8. SETTINGS.....	12
9. BEFORE FIRST USE.....	14
10. DAILY USE.....	15
11. HINTS AND TIPS.....	16
12. CARE AND CLEANING.....	16
13. TROUBLESHOOTING.....	19
14. TECHNICAL DATA.....	20
15. WARRANTY .....	21

## IMPORTANT INFORMATION THAT MAY IMPACT YOUR MANUFACTURER'S WARRANTY

Adherence to the directions for use in this manual is extremely important for health and safety. Failure to strictly adhere to the requirements in this manual may result in personal injury, property damage and affect your ability to make a claim under the Electrolux manufacturer's warranty provided with your product. Products must be used, installed and operated in accordance with this manual. You may not be able to claim on the Electrolux manufacturer's warranty in the event that your product fault is due to failure to adhere to this manual.

## WE'RE THINKING OF YOU

Thank you for purchasing an Electrolux appliance. You've chosen a product that brings with it decades of professional experience and innovation. Ingenious and stylish, it has been designed with you in mind. So whenever you use it, you can be safe in the knowledge that you'll get great results every time. Welcome to Electrolux.

### Visit our website for:



Get usage advice, brochures, trouble shooter, service information:  
[www.electrolux.com](http://www.electrolux.com)



Register your product for better service:  
[www.registerelectrolux.com](http://www.registerelectrolux.com)

## CUSTOMER CARE AND SERVICE

Always use original spare parts.

When contacting our Authorised Service Centre, ensure that you have the following data available: Model, PNC, Serial Number.

The information can be found on the rating plate.

Warning / Caution-Safety information

 General information and tips

 Environmental information

Subject to change without notice.

## 1. SAFETY INFORMATION

Before the installation and use of the appliance, carefully read the supplied instructions. The manufacturer is not responsible if an incorrect installation and use causes injuries and damages. Always keep the instructions with the appliance for future reference.



- Read the supplied instructions.



- Warning; Risk of fire / Flammable materials

### 1.1 Children and vulnerable people safety



**WARNING!**

Risk of suffocation, injury or permanent disability.

- This appliance can be used by children aged from 8 years and above and persons with reduced physical, sensory or mental capabilities or lack of experience and knowledge if they have been given supervision or instruction concerning the use of the appliance in a safe way and understand the hazards involved.
- Children between 3 and 8 years of age and persons with very extensive and complex disabilities shall be kept away from the appliance unless continuously supervised.
- Children of less than 3 years of age should be kept away from the appliance unless continuously supervised.
- Do not let children play with the appliance.
- Keep all packaging away from children and dispose of it appropriately.
- Keep detergents away from children.

- Keep children and pets away from the appliance when the door is open.
- If the appliance has a child safety device, it should be activated.
- Children shall not carry out cleaning and user maintenance of the appliance without supervision.

## 1.2 General Safety

- Do not change the specification of this appliance.
- If the tumble dryer is put on top of a washing machine, use the stacking kit. The stacking kit, available from your authorized vendor, can be used only with the appliance specified in the instructions supplied with the accessory. Read it carefully before installation (refer to the Installation leaflet).
- The appliance can be installed as freestanding or below a kitchen counter with correct space (refer to the Installation leaflet).
- Do not install the appliance behind a lockable door, a sliding door or a door with a hinge on the opposite side, that would prevent the appliance door from being fully open.
- The ventilation opening in the base must not be covered by a carpet, mat, or any floor covering.
- **WARNING:** The appliance must not be supplied through an external switching device, such as a timer, or connected to a circuit that is regularly switched on and off by a utility.
- Connect the mains plug to the mains socket only at the end of the installation process. Make sure that the mains plug is accessible after installation.
- If the mains power supply cable is damaged, it must be replaced by the manufacturer, its Authorised Service Centre or similarly qualified persons to avoid an electrical hazard.
- Do not exceed the maximum load of 8 kg (refer to the "Programme chart" chapter).

- Do not use the appliance if items have been soiled with industrial chemicals.
- Wipe away lint or packaging debris that has accumulated around the appliance.
- Do not run the appliance without a filter. Clean the lint filter before or after each use.
- Do not dry unwashed items in the tumble dryer.
- Items that have been soiled with substances such as cooking oil, acetone, alcohol, petrol, kerosene, spot removers, turpentine, waxes and wax removers should be washed in hot water with an extra amount of detergent before being dried in the tumble dryer.
- Items such as foam rubber (latex foam), shower caps, waterproof textiles, rubber backed articles and clothes or pillows fitted with foam rubber pads should not be dried in the tumble dryer.
- Fabric softeners, or similar products, should only be used as specified by the product manufacturer's instructions.
- Remove all objects from items that could be a source of fire ignition such as lighters or matches.
- **WARNING:** Never stop a tumble dryer before the end of the drying cycle unless all items are quickly removed and spread out so that the heat is dissipated.
- Before any maintenance operation, deactivate the appliance and disconnect the mains plug from the socket.

## 2. CONDITIONS OF USE

This appliance is intended to be used in household and similar applications such as:

- Farm houses

- By clients in serviced apartments, holiday apartments and other residential type environments.

## 3. SAFETY INSTRUCTIONS

### 3.1 Installation

- Remove all the packaging.
- Do not install or use a damaged appliance.
- Follow the installation instructions supplied with the appliance.
- Always take care when moving the appliance as it is heavy. Always use safety gloves and enclosed footwear.

- Do not install or use the appliance where the temperature can be lower than 5°C or higher than 35°C.
- The floor area on which the appliance is to be installed must be flat, stable, heat resistant and clean.
- Make sure that there is air circulation between the appliance and the floor.
- Always keep the appliance vertical when it is being moved.
- The rear surface of the appliance must be put against a wall.
- When the appliance is in its permanent position, check if it is levelled correctly with the aid of a spirit level. If it is not, adjust the feet accordingly.
- Only dry fabrics which are applicable to dry in the tumble dryer. Follow the instructions on the fabric label.
- If you have washed your laundry with a stain remover start an extra rinse cycle before you start the dryer.
- Do not drink or prepare food with the condensed water/distilled water. It can cause health problems to people and pets.
- Do not sit or stand on the open door.
- Do not dry dripping wet clothes in the tumble dryer.
- Oil-affected items can ignite spontaneously, especially when exposed to heat sources such as in a tumble dryer. The items become warm, causing an oxidation reaction in the oil. Oxidation creates heat. If the heat cannot escape, the items can become hot enough to catch fire. Piling, stacking or storing oil-affected items can prevent heat from escaping and create a fire hazard.
- If it is unavoidable that fabrics that contain vegetable or cooking oil or have been contaminated by hair care products be placed in a tumble dryer they should first be washed in hot water with extra detergent -this will reduce, but not eliminate, the hazard.

### 3.2 Electrical connection



#### **WARNING!**

Risk of fire and electric shock.

- Connect the mains plug to the mains socket only at the end of the installation. Make sure that there is access to the mains plug after the installation.
- The appliance must be earthed.
- Make sure that the parameters on the rating plate are compatible with the electrical ratings of the mains power supply.
- Always use a correctly installed shockproof socket.
- Do not use multi-plug adapters and extension cables.
- Do not pull the mains cable to disconnect the appliance. Always pull the mains plug.
- Do not touch the mains cable or the mains plug with wet hands.
- This appliance complies with the E.E.C. Directives.

### 3.3 Use



#### **WARNING!**

Risk of injury, electric shock, fire, burns or damage to the appliance.

- Do not dry the damaged items which contain padding or fillings.

### 3.4 Internal lighting



#### **WARNING!**

Risk of injury.

- Visible LED radiation, do not look directly into the beam.
- The LED lamp is dedicated to drum lighting. This lamp cannot be reused for other lighting purposes.
- To replace the internal lighting, contact the Authorised Service Centre.

### 3.5 Care and cleaning



#### **WARNING!**

Risk of injury or damage to the appliance.

- Do not use water spray and steam to clean the appliance.
- Clean the appliance with a moist soft cloth. Only use neutral detergents. Do

not use any abrasive products, abrasive cleaning pads, solvents or metal objects.

- To prevent damage to the cooling system be careful when you clean the appliance.

### 3.6 Compressor



#### **WARNING!**

Risk of damage to the appliance.

- The compressor and its system in the tumble dryer is filled with the special agent which is free from fluoro-chloro-hydrocarbons. This system must stay tight. The damage of the system can cause a leakage.

### 3.7 Service

- To repair the appliance contact the Authorised Service Centre.

## 4. PRODUCT DESCRIPTION

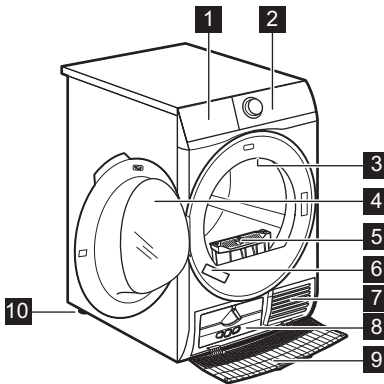

- 1** Water container
- 2** Control panel
- 3** Internal light
- 4** Appliance door
- 5** Filter
- 6** Rating plate
- 7** Airflow slots
- 8** Heat Exchanger lid
- 9** Heat Exchanger cover
- 10** Adjustable feet



For ease of loading laundry or ease of installation the door is reversible. (see separate leaflet).

- Use original spare parts only.

### 3.8 Disposal



#### **WARNING!**

Risk of injury or suffocation.

- Disconnect the appliance from the mains electrical and water supplies.
- Cut off the mains electrical cable close to the appliance and dispose of it.
- Remove the door catch to prevent children or pets from becoming trapped in the drum.
- Dispose of the appliance in accordance with local requirements for the disposal of Waste Electrical and Electronic Equipment (WEEE).

## 5. CONTROL PANEL

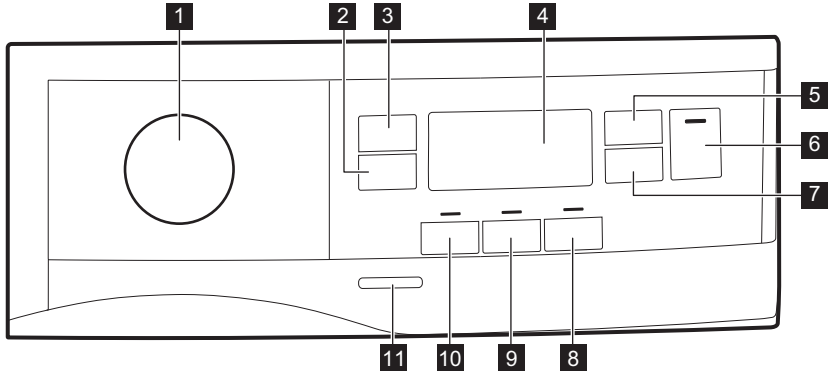

- 1** Programme knob
- 2** Extra Anticrease touch button
- 3** Dryness Level touch button
- 4** Display
- 5** Time Dry touch button
- 6** Start/Pause touch button
- 7** Delay Start touch button
- 8** End Alert touch button
- 9** Reverse Plus touch button
- 10** Extra Silent touch button

- 11** On/Off button







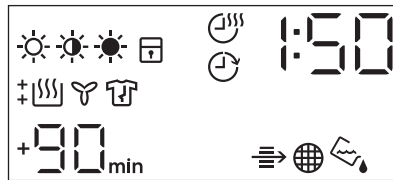

Press the touch buttons with your finger in the area with the symbol or name of the option. Do not wear gloves when you operate the control panel. Make sure that the control panel is always clean and dry.

### 5.1 Display





















Symbol on the display	Symbol description
	laundry dryness option: iron dry, cupboard dry, extra dry
	time drying option on
	delay start option on
	indicator: <i>check Heat Exchanger</i>



Symbol on the display	Symbol description
	indicator: <i>clean filter</i>
	indicator: <i>drain the water container</i>
	child lock on
— — —	wrong selection or knob is in the ● "Reset" position
	indicator: <i>drying phase</i>
	indicator: <i>cooling phase</i>
	indicator: <i>anti-crease phase</i>
1 : 50	programme duration
+30 <sub>min.</sub> , +60 <sub>min.</sub> , +90 <sub>min.</sub> , +2h	extension of default anti-crease phase: +30min, +60min, +90min, +2h)
: 10 - 2 : 00	time drying selection (10min-2h)
1h - 20h	delay start selection (1h-20h)

## 6. PROGRAMME TABLE

Programme	Load <sup>1)</sup>	Properties / Fabric type <sup>2)</sup>
Favourite ☆	Depends on a memorised programme	You can do your configuration of programme and options and memorise in the appliance memory (See chapter " <i>Settings - Favourite ☆</i> ").
Cottons <sup>3)</sup>	<b>8 kg</b>	Cotton fabrics. /  
Mixed +	<b>6 kg</b>	Mix of garments made of cotton, cotton-synthetic blend and synthetic fabric. /   
Bedding +	<b>4,5 kg</b>	Up to three bed linen sets, one of which can be double size. /   
Synthetics	<b>3,5 kg</b>	Synthetic and mixed fabrics. /   
Energy Saver	<b>8 kg</b>	Cycle to be used to dry cotton with "cotton cupboard" dryness level, with maximum energy saving. /   
Refresh	<b>1kg</b>	Refreshing textiles that were in storage.

Programme	Load 1)	Properties / Fabric type <sup>2)</sup>
Drying Rack	1kg (or 1 pair of sport shoes)	For drying sport shoes only with Drying Rack (see separate user manual provided with Drying Rack).
Sports	2 kg	Sportswear, thin and light fabrics, microfiber, polyester. / 
Silk	1 kg	Gentle drying of hand-washable silks.
Shirts	1,5kg (or 7 shirts)/	Easy care fabrics for which a minimum of ironing is necessary. The drying results can be different from one type of fabric to the other. Shake the items before you put them in the appliance. When the programme is completed, Immediately remove the items and put them on a hanger. / 
Wool 	1 kg	<p>Woollen fabrics. Gentle drying for hand-washable woollens. Remove items immediately when the programme is completed.</p> <div data-bbox="571 766 952 1013" style="text-align: center;">  <p><b>WOOL HAND WASH SAFE</b></p> </div> <p>The wool drying cycle of this machine has been approved by The Woolmark Company for the drying of wool garments labelled as "hand wash" provided that the garments are dried according to the instructions issued by the manufacturer of this machine. Follow the garment care label for other laundry instructions. M1525</p>
Delicates	4 kg	Delicate fabrics such as viscose, rayon, acrylic, and their blends. / 

1) The maximum weight refers to dry items.

2) For fabric mark meaning see chapter *HINTS AND TIPS: Preparing the laundry*.

3) For test institutes only: the Cottons program in combination with the extra dry  Dryness Level is the "Standard cotton program". It is suitable for drying normal wet cotton laundry and it is the most efficient program in terms of energy consumption for drying wet cotton laundry. Standard programme for tests are specified in the AS/NZS2442.2 document.



## 7. OPTIONS

### 7.1 Extra Anticrease

Extends the anti-crease phase by 30,60, 90 or 2 hours at the end of the drying cycle. This function reduces creases. The laundry can be removed during the anti-crease phase.

### 7.2 Dryness Level

This function helps to increase dryness of the laundry. There are 3 options:

-  Extra Dry
-  Cupboard Dry
-  Iron Dry

### 7.3 Time Dry

You can set the programme duration, from a minimum of 10 minutes to a maximum of 2 hours. The required duration is related to the quantity of laundry in the appliance.



We recommend that you set a short duration for small quantities of laundry or for only one item.



### 7.4 Time Dry on Wool programme

Option suitable for Wool programme to adjust final dryness level.

### 7.5 Time Dry on Drying Rack programme

Option suitable for Drying Rack programme .

### 7.9 Options table

Programmes <sup>1)</sup>	Dryness Level	Extra Anti-crease	Extra Silent	Reverse Plus	Time Dry
	  				
Favourite ☆	Depends on a memorised programme				

You can set the programme duration, from a minimum of 10 minutes to a maximum of 2 hours. The setting of the duration is related to the quantity of laundry in the appliance.

We recommend that you set a short duration for small quantities of laundry or for only one item.

### 7.6 End Alert

The buzzer sounds at the:

- cycle end
- start and end of the anti-crease phase
- cycle interruption

The buzzer function is by default always on. You can use this function to activate or deactivate the sound.



You can activate the End Alert option with all programmes.

### 7.7 Reverse Plus

Increase drum reversing frequency to reduce items twisting and entanglement. To increase uniformity of drying result and help reduce creases. Recommended for large or long items (e.g. sheets, trousers, long dresses)"

### 7.8 Extra Silent

The appliance operates with low noise without effect on the drying quality. The appliance operates slowly with longer cycle time.

Programmes <sup>1)</sup>	Dryness Level	Extra Anti-crease	Extra Silent	Reverse Plus	Time Dry
Cottons	■ ■ ■	■	■	■	■
Mixed +	■ ■	■		■	■
Bedding +	■ ■ ■	■		■	
Synthetics	■ ■ ■	■	■	■	■
Energy Saver	■	■			
Refresh		■			
Drying Rack					■ 2)
Sports	■	■			
Silk	■	■			
Shirts		■	■		
Wool 					■ 3)
Delicates	■	■			

1) Together with the programme you can set 1 or more options. To activate or deactivate them, press the related touch button.

2) See chapter OPTIONS: Time Dry on Drying Rack programme

3) See chapter OPTIONS: Time Dry on Wool programme

## 8. SETTINGS

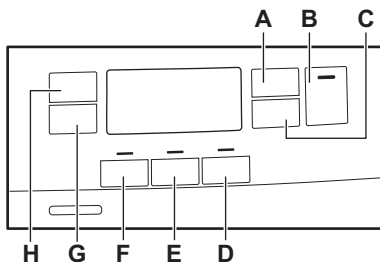

- A. Time Dry touch button
- B. Start/Pause touch button
- C. Delay Start touch button
- D. End Alert touch button
- E. Reverse Plus touch button
- F. Extra Silent touch button
- G. Extra Anticrease touch button
- H. Dryness Level touch button

### 8.1 Child lock function

This option prevents children playing with the appliance while a programme is operating. The touch buttons are locked.

Only the on/off button is unlocked.

Activating the child lock option:

1. Press the on/off button to activate the appliance.
2. Press and hold touch button (D) for a few seconds.

The child lock indicator comes on.

**i** It is possible to deactivate the child lock option while a programme operates. Press and hold the same touch buttons until the child lock indicator goes off. The Child Lock function isn't available for 8 s after switching on the appliance.

## 8.2 Favourite ☆

You can do your configuration of programme and options and memorise in the appliance memory.

### To memorise your configuration:

1. Press the on/off button to activate the appliance
2. Set the programme and available options.
3. Press the (E) button for some seconds.

The sound and the message on the display confirm that the configuration is memorised.

### To activate your memorised configuration:

1. Press the on/off button to activate the appliance.
2. Use the programme knob to set Favourite ☆ position.

Previously memorised configuration of programme and options will be restore.

## 8.3 Adjustment of the remaining moisture

The appliance allows you to chose between 3 levels corresponding to different ranges of water hardness.

Dryness level	ppm	the results from the included water hardness kit.
- 0 -	< 150	C01-C03

Dryness level	ppm	the results from the included water hardness kit.
- 1 -	150 - 300	C04-C05
- 2 -	> 300	C06-C07

Depending on the country, the water hardness is expressed in equivalent scales: e.g. French degrees (°f), German degrees (°d), English degrees (°e), mmol/l and ppm

If necessary, please contact your local water authority to check the water hardness in your area.

**i** Every time you enter in the "Adjustment of remaining laundry moisture" mode, previously set degree of remaining moisture will change into next value ( e.g previously set - 2 - will change into - 1 -).

To change the default degree of remaining moisture:







1. Press the on/off button to activate the appliance.
2. Use the programme knob to set any programme.
3. Wait approximately 8 seconds.
4. Press and hold buttons (E) and (D) at the same time.

One of these indicators comes on:

- - 0 - maximum dryness
  - - 1 - more dry laundry
  - - 2 - standard dry laundry
5. Press and hold buttons (E) and (D) again until the indicator of the correct level comes on.

**i** If the display returns to the normal mode (the time of the selected programme from step 2. will be displayed), while setting the degree of remaining moisture, press and hold buttons **(E)** and **(D)** once again to enter to the "Adjustment of remaining laundry moisture" mode (previously set degree of remaining moisture will change into next value).

6. To accept the selected degree of remaining moisture, wait 5 s and the display returns to the normal mode.

Dryness level	Display symbol
-  - maximum dryness	+ 
-  - more dry laundry	+ 
-  - standard dry laundry	

## 8.4 Water container indicator

By default, the water container indicator is on. It comes on when the programme

is completed or when it is necessary to empty the water container.

**i** If a draining kit is installed (additional accessory), the appliance automatically drains the water from the water container. In this case we recommend that you deactivate the indicator of the water container.

## Deactivating the water container indicator:

1. Press the on/off button to activate the appliance.
2. Wait approximately 8 seconds.
3. Press and hold touch buttons **(A)** and **(C)** at the same time.

The display shows one of these 2 configurations:

- The display shows "Off". After 5 s the display returns to normal mode.
- The display shows "On". After 5 s the display returns to normal mode.

## 9. BEFORE FIRST USE

**i** Rear drum packaging is removed automatically when dryer is activated for the first time. Possible to hear some noise.

Before you use the appliance for the first time:

- Clean the tumble dryer drum with a moist cloth.
- Start a 1 hour programme with moist laundry.

**i** At the beginning of the drying cycle (first 3-5 min) there could be a slightly higher sound level. This is due to the compressor starting up. This is normal for compressor powered appliances such as refrigerators and freezers.

## 10. DAILY USE

### 10.1 Start a programme without delay start

1. Prepare the laundry and load the appliance.



#### CAUTION!

Make sure that when you close the door, the laundry does not get caught between the appliance door and the rubber seal.

2. Press the on/off button to activate the appliance.
3. Set the correct programme and options for the type of load.

The display shows the programme duration.



The drying time you see on the display, when the cotton programme is selected, is related to the load of 5 kg and standard conditions. Real drying time will depend on type of the load (quantity and composition), the room temperature and the humidity of your laundry after spin drying phase.

4. Press the Start/Pause touch button. The programme starts.

### 10.2 Starting the programme with delay start

1. Set the correct programme and options for the type of load.
2. Press the delay start button again and again until the display shows the delay time you want to set.



You can delay the start of a programme from a minimum of 1 hour to a maximum of 20 hours.

3. Press the Start/Pause touch button. The display shows the countdown of the delay start.

When the countdown is completed, the programme starts.

### 10.3 Change a programme

1. Press the on/off button to deactivate appliance
2. Press the on/off button to activate the appliance.
3. Set the programme.

### 10.4 At the end of the programme

When the programme is completed:

- An intermittent acoustic signal operates.
- The display shows :
- The indicator is on.
- The indicators Filter and Tank may come on.
- The Start/Pause indicator is on.

The appliance continues to operate with the anti-crease phase for approximately 30 minutes or more if Extra Anticrease option was set (see chapter *Option - Extra Anticrease*).

The anti-crease phase reduces creasing.

You can remove the laundry before the anti-crease phase is completed. We recommend, for better results, that you remove the laundry when the phase is almost completed.

When the anti-crease phase is completed:

- The display still shows :
- The indicator is off.
- The indicators Filter and Tank remain on.
- Start/Pause indicator goes off.

1. Press the on/off button to deactivate the appliance.
2. Open the appliance door.
3. Remove the laundry.
4. Close the appliance door.



**Always clean the filter and empty the water container when a programme is completed.**

### 10.5 Stand-by function





To reduce energy consumption, this function automatically deactivates the appliance:

- After 5 minutes if you do not start the programme.
- After 5 minutes from the end of the programme.

## 11. HINTS AND TIPS

### 11.1 Preparing the laundry

- Close the zips.
- Close the fasteners of duvet covers.
- Do not dry ties or ribbons loose (e.g. apron ribbons). Tie them before you start a programme.
- Remove all items from pockets.
- Turn items with the internal layer made of cotton inside out. Cotton layer must be faced outwards.
- Always set the programme suitable for the type of laundry.
- Do not put light and dark colours together.
- Use suitable programme for cottons, jersey and knitwear to reduce shrinkage.
- Do not exceed the maximum load stated in the programmes chapter or shown on the display.
- Dry only the laundry that is suitable for tumble drying. Refer to the fabric label on the items.
- Do not dry large and small items together. Small items can be trapped inside the large items and remain wet.

Fabric label	Description
	Laundry is suitable for tumble drying.
	Laundry is suitable for tumble drying at higher temperatures.
	Laundry is suitable for tumble drying at low temperatures only.
	Laundry is not suitable for tumble drying.

## 12. CARE AND CLEANING

### 12.1 Cleaning the filter

1.

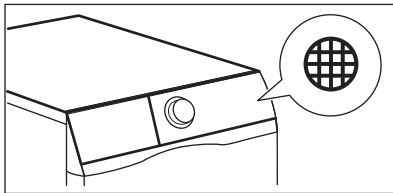

2.

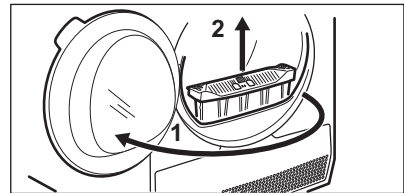



3.

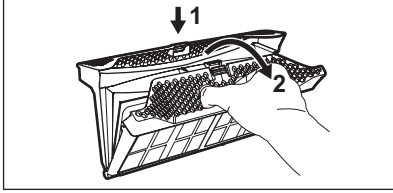

4.

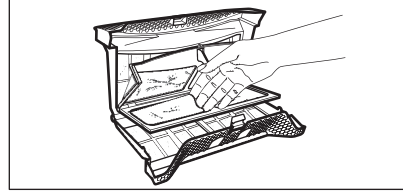

5. 1)

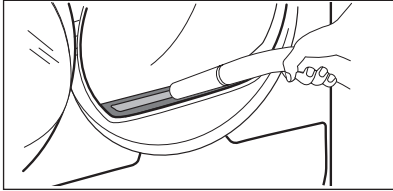

6.

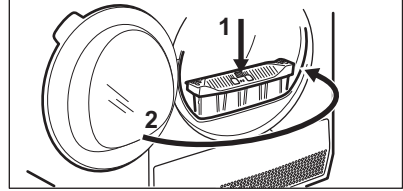

1) If necessary remove fluff from the filter socket and gasket. You can use a vacuum cleaner.

## 12.2 Emptying the water container

1.

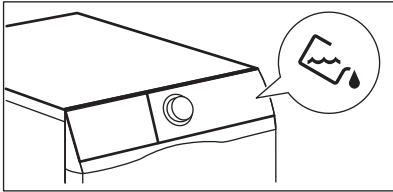

2.

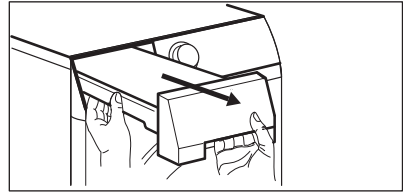

3.

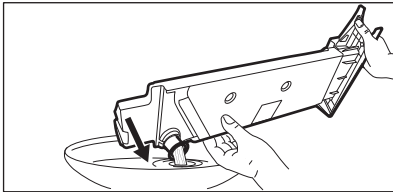

4.

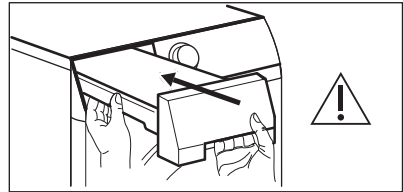

You can use the water from the water container as an alternative to distilled water (e.g. for steam ironing). Before you use the water, remove dirt residues with a filter.

### 12.3 Cleaning the Heat Exchanger

1.

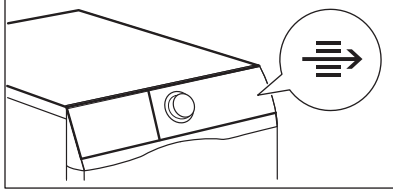

2.

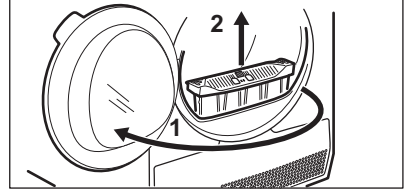

3.

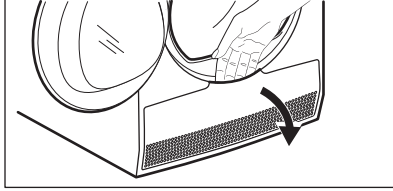

4.

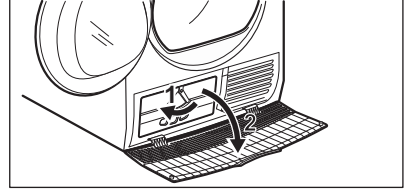

5.

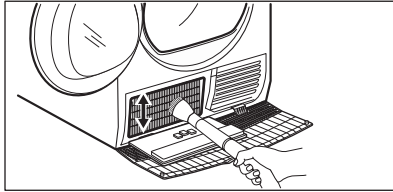

6.

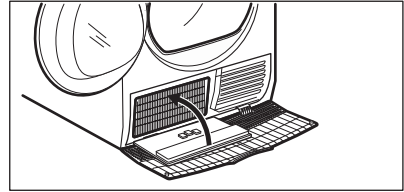

7.

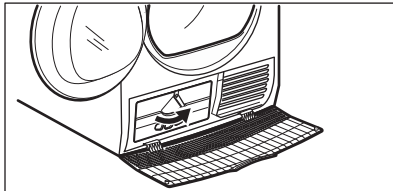

8.

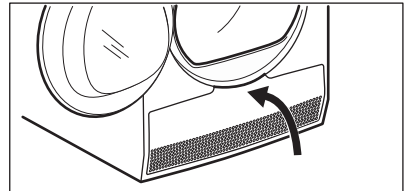

9.

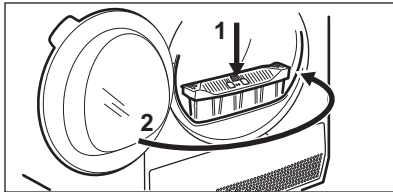

**CAUTION!**

Do not touch the metal surface with bare hands. Risk of injury. Wear protective gloves. Clean carefully to avoid damaging the metal surface.

**12.4 Cleaning the drum****WARNING!**

Disconnect the appliance before you clean it.

Use a standard neutral soap detergent to clean the inner surface of the drum and drum lifters. Dry the cleaned surfaces with a soft cloth.

**CAUTION!**

Do not use abrasive materials or steel wool to clean the drum.

**12.5 Cleaning the control panel and housing**

Use a standard neutral soap detergent to clean the control panel and housing.

Use a moist cloth to clean. Dry the cleaned surfaces with a soft cloth.

**CAUTION!**

Do not use furniture cleaning agents or cleaning agents which can cause corrosion.

**12.6 Cleaning the airflow slots**

Use a vacuum cleaner to remove fluff from the airflow slots.

**13. TROUBLESHOOTING**

<b>Problem</b>	<b>Possible solution</b>
You cannot activate the appliance.	Make sure that the mains plug is connected to the mains socket.
	Check fuse in fuse box (domestic installation).
The programme does not start.	Press Start/Pause.
	Make sure that the appliance door is closed.
The appliance door does not close.	Make sure that the installation of the filter is correct.
	Make sure that the laundry is not caught between the appliance door and the rubber seal.
The appliance stops during operation.	Make sure that the water container is empty. Press Start/Pause to start the programme again.
	Load is too small, increase the load or use the Time Drying programme.
The cycle time is too long or unsatisfactory drying result. <sup>1)</sup>	Make sure that the weight of the laundry is suitable for the duration of the programme.

Problem	Possible solution
	Make sure that the filter is clean.
	The laundry is too wet. Spin the laundry in the washing machine again.
	Ensure that the room temperature is higher than +5°C and lower than +35°C. Optimal room temperature is 19°C to 24°C.
	Set the Time Drying or the Extra Dry programme. <sup>2)</sup>
The display shows — — —.	If you want to set a new programme, deactivate and activate the appliance.
	Make sure that the options are suitable for the programme.
The display shows Error code (e.g. <b>E51</b> ).	Deactivate and activate the appliance. Start a new programme. If the problem occurs again, contact the Service centre.

1) After maximum 5 hours, the programme ends automatically.

2) It can happen that some area remains humid when drying big items (e.g. bed sheets ).

### 13.1 If the drying results are not satisfactory

- The set programme was incorrect.
- The filter is clogged.
- The Heat Exchanger is clogged.
- There was too much laundry in the appliance.
- The drum is dirty.
- Incorrect setting of the conductivity sensor ( See chapter "*Settings - Adjustment of the remaining laundry moisture degree*" for better setting).
- The airflow slots are clogged.
- Room temperature is too low or too high ( optimal room temperature 19°C to 24°C )

## 14. TECHNICAL DATA

Height x Width x Depth	850 x 600 x 600 mm (maximum 665 mm)
Max. depth with the appliance door open	1100 mm
Max. width with the appliance door open	950 mm
Adjustable height	850 mm (+ 15 mm - feet regulation)
Drum volume	118 l
Maximum load volume	<b>8 kg</b>
Voltage	230-240 V
Frequency	50 Hz
Total power	900 W

Type of use	Household
Permitted ambient temperature	+ 5°C to + 35°C
Level of protection against ingress of solid particles and moisture ensured by the protective cover, except where the low voltage equipment has no protection against moisture	<b>IPX4</b>
This product contains fluorinated greenhouse gases, hermetically sealed	
Gas designation	R134a
Weight	0,30 kg
Global-warming potential (GWP)	1430

## 15. WARRANTY

FOR SALES IN AUSTRALIA AND NEW ZEALAND

APPLIANCE: ELECTROLUX DRYER

**This document sets out the terms and conditions of the product warranties for Electrolux Appliances. It is an important document. Please keep it with your proof of purchase documents in a safe place for future reference should there be a manufacturing defect in your Appliance. This warranty is in addition to other rights you may have under the Australian Consumer Law.**

### 1. In this warranty:

- a) 'ACL' or 'Australian Consumer Law' means Schedule 2 to the Competition and Consumer Act 2010;
- b) 'Appliance' means any Electrolux product purchased by you and accompanied by this document;
- c) 'ASC' means Electrolux authorised service centres;
- d) 'Electrolux' is the brand controlled Electrolux Home Products Pty Ltd of 163 O'Riordan Street, Mascot NSW 2020, ABN 51 004 762 341 in respect of Appliances purchased in Australia and Electrolux (NZ) Limited (collectively "Electrolux") of 3-5 Niall Burgess Road, Mount Wellington, in respect of

Appliances purchased in New Zealand;

- e) 'Warranty Period' means the period specified in clause 3 of this warranty;
  - f) 'you' means the purchaser of the Appliance not having purchased the Appliance for re-sale, and 'your' has a corresponding meaning.
2. **Application:** This warranty only applies to new Appliances, purchased and used in Australia or New Zealand and is in addition to (and does not exclude, restrict, or modify in any way) other rights and remedies under a law to which the Appliances or services relate, including any nonexcludable statutory guarantees in Australia and New Zealand.
3. **Warranty Period:** Subject to these terms and conditions, this warranty continues for in Australia for a period of 24 months and in New Zealand for a period of 24 months, following the date of original purchase of the Appliance.
4. **Repair or replace warranty:** During the Warranty Period, Electrolux or its ASC will, at no extra charge if your Appliance is readily accessible for service, without special equipment and subject to these terms and conditions, repair or replace any parts which it considers to be

- defective. Electrolux may, in its absolute discretion, choose whether the remedy offered for a valid warranty claim is repair or replacement. Electrolux or its ASC may use refurbished parts to repair your Appliance. You agree that any replaced Appliances or parts become the property of Electrolux.
5. **Travel and transportation costs:** Subject to clause 7, Electrolux will bear the reasonable cost of transportation, travel and delivery of the Appliance to and from Electrolux or its ASC. Travel and transportation will be arranged by Electrolux as part of any valid warranty claim.
  6. **Proof of purchase** is required before you can make a claim under this warranty.
  7. **Exclusions:** You may not make a claim under this warranty unless the defect claimed is due to faulty or defective parts or workmanship. This warranty does not cover:
    - a) light globes, batteries, filters or similar perishable parts;
    - b) parts and Appliances not supplied by Electrolux;
    - c) cosmetic damage which does not affect the operation of the Appliance;
    - d) damage to the Appliance caused by:
      1. negligence or accident;
      2. misuse or abuse, including failure to properly maintain or service;
      3. improper, negligent or faulty servicing or repair works done by anyone other than an Electrolux authorised repairer or ASC;
      4. normal wear and tear;
      5. power surges, electrical storm damage or incorrect power supply;
      6. incomplete or improper installation;
      7. incorrect, improper or inappropriate operation;
      8. insect or vermin infestation;
      9. failure to comply with any additional instructions supplied with the Appliance;
- In addition, Electrolux is not liable under this warranty if:
- a. the Appliance has been, or Electrolux reasonably believes that the Appliance has been, used for purposes other than those for which the Appliance was intended, including where the Appliance has been used for any non-domestic purpose;
  - b. the Appliance is modified without authority from Electrolux in writing;
  - c. the Appliance's serial number or warranty seal has been removed or defaced
8. **How to claim under this warranty:** To enquire about claiming under this warranty, please follow these steps:
    - a. carefully check the operating instructions, user manual and the terms of this warranty;
    - b. have the model and serial number of the Appliance available;
    - c. have the proof of purchase (e.g. an invoice) available;
    - d. telephone the numbers shown below.
  9. **Australia:** For Appliances and services provided by Electrolux in Australia: Electrolux goods come with guarantees that cannot be excluded under the Australian Consumer Law. You are entitled to a replacement or refund for a major failure and for compensation for any other reasonably foreseeable loss or damage. You are also entitled to have the Appliance repaired or replaced if the Appliance fails to be of acceptable quality and the failure does not amount to a major failure. 'Acceptable quality' and 'major failure' have the same meaning as referred to in the ACL.
  10. **New Zealand:** For Appliances and services provided by Electrolux in New Zealand, the Appliances come with a guarantee by Electrolux pursuant to the provisions of the Consumer Guarantees Act, the Sale of Goods Act and the Fair Trading Act. Where the Appliance was purchased in New Zealand for

commercial purposes the Consumer Guarantee Act does not apply.

**11. Confidentiality:** You accept that if you make a warranty claim, Electrolux and its agents including

ASC may exchange information in relation to you to enable Electrolux to meet its obligations under this warranty.

<p><b>FOR SERVICE</b> or to find the address of your nearest state service centre in Australia <b>Please call 13 13 49</b> For the cost of a local call (Australia only)</p>	<p><b>AUSTRALIA</b> ELECTROLUX HOME PRODUCTS 163 O’Riordan Street, Mascot NSW 2020 <a href="http://www.electrolux.com.au">www.electrolux.com.au</a></p>	<p><b>FOR SPARE PARTS</b> or to find the address of your nearest state spare parts centre in Australia <b>Please call 13 13 50</b> For the cost of a local call (Australia only)</p>
--	---	--

<p><b>FOR SERVICE</b> or to find the address of your nearest authorised service centre in New Zealand <b>Free call 0800 10 66 10</b> (New Zealand only)</p>	<p><b>NEW ZEALAND</b> ELECTROLUX (NZ) Limited 3-5 Niall Burgess Road, Mount Wellington <a href="http://www.electrolux.co.nz">www.electrolux.co.nz</a></p>	<p><b>FOR SPARE PARTS</b> or to find the address of your nearest state spare parts centre in New Zealand <b>Free call 0800 10 66 20</b> (New Zealand only)</p>
---	---	--

EDryer\_Warr\_May\_17

## 16. ENVIRONMENTAL CONCERNS

Recycle materials with the symbol . Put the packaging in relevant containers to recycle it. Help protect the environment and human health by recycling waste of electrical and electronic appliances. Do not dispose of

appliances marked with the symbol  with the household waste. Return the product to your local recycling facility or contact your municipal office.

www.shop.electrolux.com.au



136959641-A-502018

