

EWF12853  
EWF12753  
EWF12753E



---

EN Washing Machine

---

User Manual

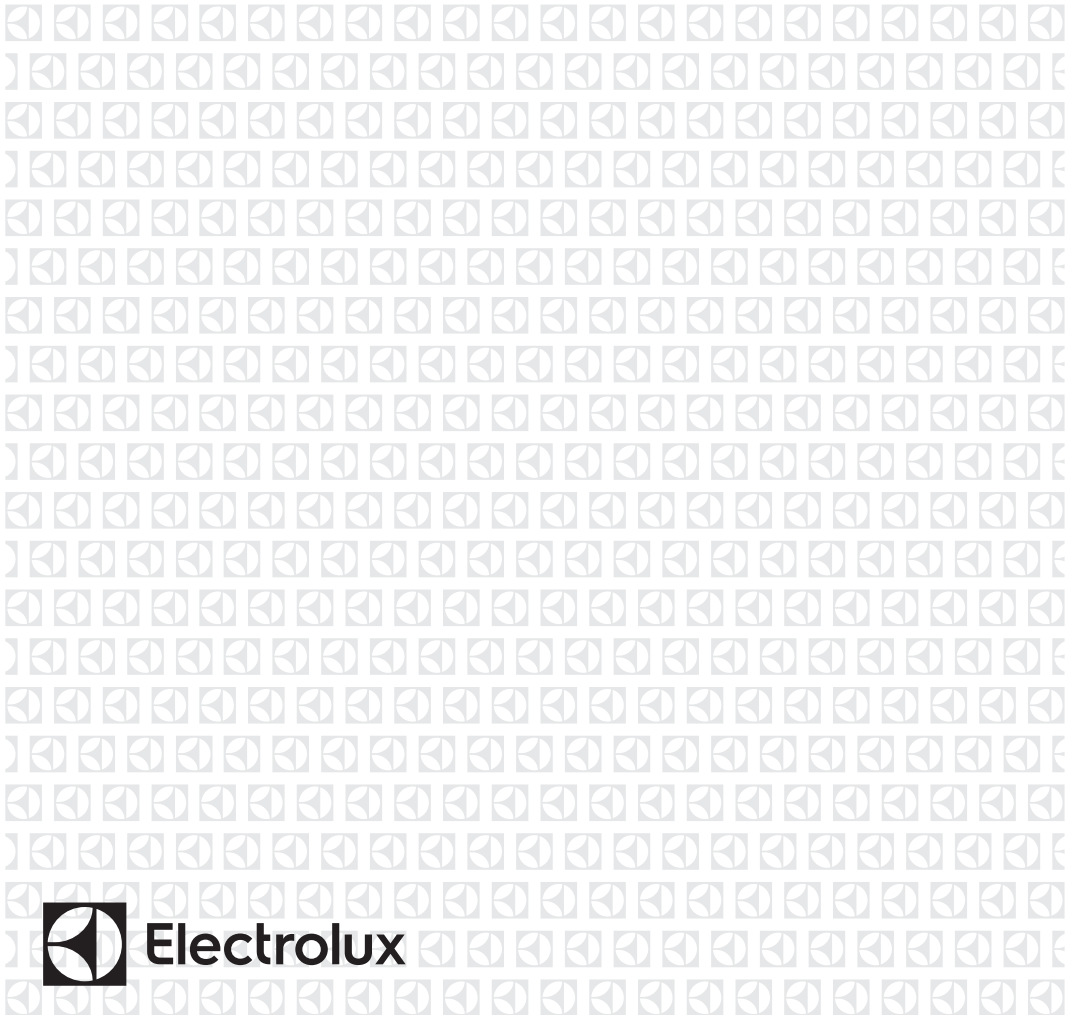

## WE'RE THINKING OF YOU

Thank you for purchasing an Electrolux appliance. You've chosen a product that brings with it decades of professional experience and innovation. Ingenious and stylish, it has been designed with you in mind. So whenever you use it, you can be safe in the knowledge that you'll get great results every time. Welcome to Electrolux.



**Visit our website to:**



Get usage advice, brochures, trouble shooter, service information, buy accessories & spare parts, online product registration : **www.electrolux.com**

## CUSTOMER CARE AND SERVICE

We recommend the use of original spare parts. When contacting Service, ensure that you have the following data available. The information can be found on the rating plate. Model, PNC, Serial Number.

-  Warning / Caution-Safety information.
-  General information and tips
-  Environmental information.

Subject to change without notice.

## CONTENTS

|  |           |
|--|-----------|
| <b>1. SAFETY INFORMATION</b>                             |           |
| 1.1 Conditions Of Use .....                              | 4         |
| 1.2 Child Safety .....                                   | 4         |
| 1.3 Child Safety Device (Door Block Button) .....        | 5         |
| 1.4 General Safety .....                                 | 5         |
| 1.5 Installation .....                                   | 6         |
| 1.6 Use .....  | 6         |
| <b>2. PRODUCT DESCRIPTION</b>                            |           |
| 2.1 Parts .....  | 7         |
| 2.2 Accessories .....                                    | 8         |
| <b>3. CONTROL PANEL</b>                                  |           |
| 3.1 Control Panel Description .....                      | 9         |
| 3.2 Display .....  | 9         |
| 3.3 Program Chart .....                                  | 10        |
| 3.4 Program Options Compatibility .....                  | 11        |
| 3.5 Options .....  | 11        |
| 3.6 Settings .....                                       | 12        |
| 3.7 Start/Pause (▶  ) and Add Clothes (↺) Touchpad ..... | 13        |
| <b>4. BEFORE FIRST USE .....</b>                         | <b>13</b> |

# CONTENTS

|  |           |
|--|-----------|
| <b>5. DAILY USE</b>  |           |
| 5.1 Loading The Laundry.....   | 14        |
| 5.2 Using Detergent And Additives .....  | 14        |
| 5.3 Options Setting .....  | 15        |
| 5.4 Starting A Cycle.....  | 16        |
| 5.5 Interruption Of A Program .....  | 16        |
| 5.6 Changing A Program .....   | 16        |
| 5.7 Changing The Options .....   | 16        |
| 5.8 Opening The Door.....  | 16        |
| 5.9 At The End Of The Program .....  | 17        |
| 5.10 When The Washing Program Is Completed, But There Is Water In The Drum ..... | 17        |
| 5.11 AUTO Standby Function .....   | 17        |
| <b>6. WASHING HINTS</b>  |           |
| 6.1 Sorting The Laundry .....  | 18        |
| 6.2 Temperatures.....  | 18        |
| 6.3 Before Loading The Laundry.....  | 18        |
| 6.4 Maximum Loads.....   | 18        |
| 6.5 Removing Stains.....   | 18        |
| 6.6 Detergents Type And Quantity Of Detergent.....                               | 19        |
| <b>7. INTERNATIONAL WASH CODE SYMBOLS .....</b>                                  | <b>20</b> |
| <b>8. CARE AND CLEANING</b>  |           |
| 8.1 External Cleaning .....  | 20        |
| 8.2 Descaling .....  | 20        |
| 8.3 After Each Wash .....  | 20        |
| 8.4 Maintenance Wash .....   | 21        |
| 8.5 Cleaning The Dispenser Drawer.....   | 21        |
| 8.6 Cleaning The Drawer Recess .....   | 21        |
| 8.7 Cleaning The Pump.....   | 21        |
| 8.8 Cleaning The Water Inlet Filter .....  | 23        |
| 8.9 Frost Precautions .....  | 24        |
| <b>9. TROUBLESHOOTING</b>  |           |
| 9.1 Possible Failures .....  | 25        |
| 9.2 Emergency Door Opening .....   | 27        |
| <b>10. TECHNICAL DATA .....</b>  | <b>28</b> |
| <b>11. INSTALLATION</b>  |           |
| 11.1 Unpacking .....   | 29        |
| 11.2 Positioning .....   | 30        |
| 11.3 Water Inlet .....   | 31        |
| 11.4 Water Drainage .....  | 31        |
| 11.5 Electrical Connection .....   | 32        |
| <b>12. ENVIRONMENT CONCERNS</b>  |           |
| 12.1 Packaging Materials .....   | 33        |
| 12.2 Old Machine.....  | 33        |
| 12.3 Ecological Hints .....  | 33        |
| <b>WARRANTY.....</b>   | <b>35</b> |

# 1. SAFETY INFORMATION

## 1.1 Conditions Of Use

This appliance is intended to be used in household and similar applications such as:

- Farm houses
- By clients in serviced apartments, holiday apartments and residential type environments.

In the interest of your safety and to ensure the correct use, before installing and first using the appliance, read this user manual carefully, including its hints and warnings.

To avoid unnecessary mistakes and accidents, it is important to ensure that all people using the appliance are thoroughly familiar with its operation and safety features.

Save these instructions and make sure that they remain with the appliance if it is moved or sold, so that everyone using it through its life will be properly informed on appliance use and safety.

## 1.2 Child Safety

- This washing machine is not intended for use by young children or infirm persons without supervision.
- Young children should be supervised to ensure that they do not play with the appliance.
- The packaging components (e.g. plastic film, polystyrene) can be dangerous to children - danger of suffocation! Keep them out of children's reach.
- Keep all detergents in a safe place out of children's reach.

- Make sure that children or pets do not climb into the drum.
- This machine is provided with child safety lock option (  ) to prevent children playing with the control panel. (see page 12)

### 1.3 Child Safety Device (Door Block Button)

When you activate this device, you cannot close the door. This prevents children or pets to be locked in the drum.

- To activate this device, rotate the button (WITHOUT pressing it) inside the door clockwise until it stops. If necessary use a coin.

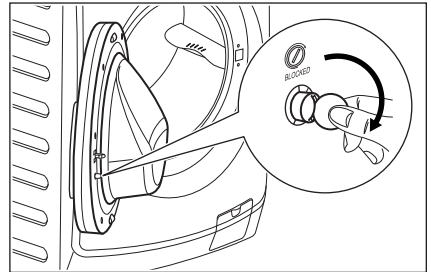

- To disable this device and restore the possibility of closing the door, rotate the button counter-clockwise until the groove is vertical.

---

### 1.4 General Safety

- It is dangerous to alter the specifications or attempt to modify this product in any way.
- During high temperature wash program the door glass may get hot. Do not touch it!
- Make sure that small pets do not climb into the drum. To avoid this, please check inside the drum before using the appliance.
- Any objects such as coins, safety pins, nails, screws, stones or any other hard, sharp material can cause extensive damage and must not be placed into the machine.
- Wash small items such as socks, laces, washable belts etc in a washing bag or pillow case as it is possible for such items to slip down between the tub and the inner drum.
- Only use manufacturer's recommended quantities of fabric softener and detergent. Damage to the fabric or appliance can occur if you exceed the recommended amount.
- Do not use your washing machine to wash articles with whalebones, material without hems or torn material.

- Always unplug the appliance and turn off the water supply after use, clean and maintenance.
- This appliance is not intended for use by persons (including children) with reduced physical, sensory or mental capabilities, or lack of experience and knowledge, unless they have been given supervision or instruction concerning use of the appliance by a person responsible for their safety.
- Under no circumstances should you attempt to repair the machine yourself. Repairs carried out by inexperienced persons may cause injury or serious malfunctioning. Contact your local Service Centre. Always insist on genuine spare parts.

## 1.5 Installation

- This appliance is heavy. Care should be taken when moving it.
- When unpacking the appliance, check that it is not damaged. If in doubt, do not use it and contact the Service Centre.
- All packing and transit bolts must be removed before use. Serious damage can occur to the product and to property if this is not adhered to. See relevant section in the user manual.
- After having installed the appliance, check that it is not standing on the inlet and drain hose and the worktop is not pressing the electrical supply cable.
- If the appliance is installed on a carpeted floor, please adjust the feet in order to allow air to circulate freely.
- Always be sure, that there is no water leakage from hoses and their connections after the installation.
- Any plumbing work required to install this appliance should be carried out by a qualified plumber.
- Any electrical work required to install this appliance should be carried out by a qualified electrician.



**May cause electric shock!** if the machine is not connected to an earthed/ground system. DO NOT touch the wet clothes and metal parts.

## 1.6 Use

- This appliance is designed for domestic use. It must not be used for purposes other than those for which it was designed.
- Only wash fabrics which are designed to be machine washed. Follow the instructions on each garment label.
- Do not overload the appliance. See the relevant section in the user manual.
- Before washing, ensure that all pockets are empty and buttons and zips are fastened. Avoid washing frayed or torn articles and treat stains such as paint, ink, rust, and grass before washing.
- Garments which have been in contact with volatile petroleum products should not be machine washed. If volatile cleaning fluids are used, care should be taken to ensure that the fluid is removed from the garment before placing in the machine.
- Never pull the power supply cable to remove the plug from the socket; always take hold of the plug itself.
- Never use the washing machine if the power supply cable, the control panel, the working surface or the base are damaged so that the inside of the washing machine is accessible.

## 2. PRODUCT DESCRIPTION

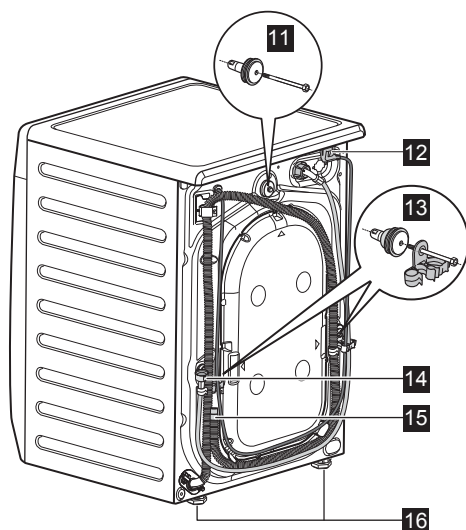
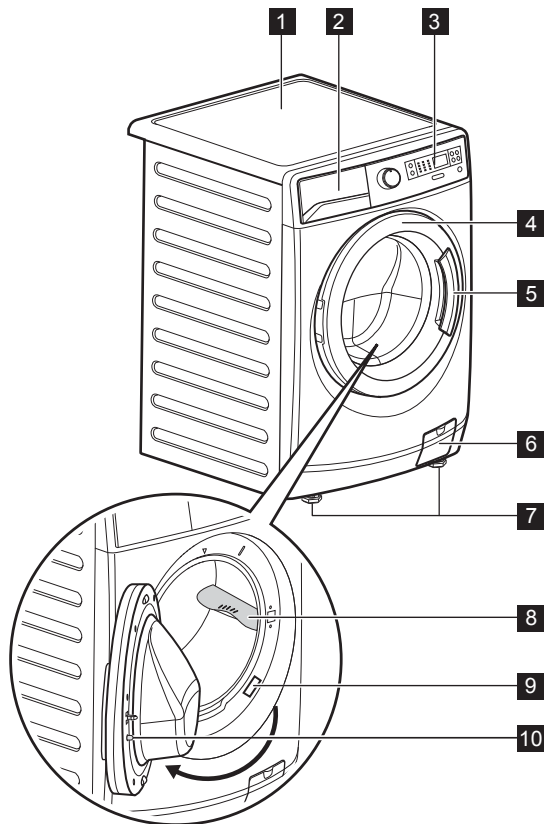

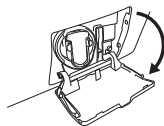

### 2.1 Parts

- 1** Worktop
- 2** Detergent/Softener Dispenser  
For more information see page 15.
- 3** Control Panel
- 4** Door
- 5** Door Handle
- 6** Drain Pump Filter



For more information see page 22.

- 7** Level Adjustment Feet (Front) 
- 8** Drum Lifter
- 9** Rating Label
- 10** Child Safety Device  
 For more information see page 5.

- 11** Transit Bolt
- 12** Mains Cable
- 13** Transit Bolts + Hose Support
- 14** Water Inlet Hose
- 15** Water Drain Hose
- 16** Level Adjustment Feet (Back) 



#### CAUTION !

All transit bolts (3 pcs) must be removed before using the appliance.

## 2.2 Accessories

- Plastic Caps



To close the holes on the rear side of the cabinet after the removal of the transit bolts.

- Plastic Hose Guide



To connect the drain hose on the edge of a sink.

- Spanner



To remove the transit bolts.  
To adjust levelling legs.

- Pedestal With The Drawer (\*Optional Extra\*)

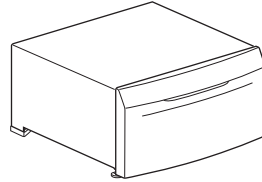

**i** This part available from your authorized vendor.

Only appropriate accessories approved by Electrolux ensure the safety standards of the appliance. If unapproved parts are used, any claims will be invalidated.

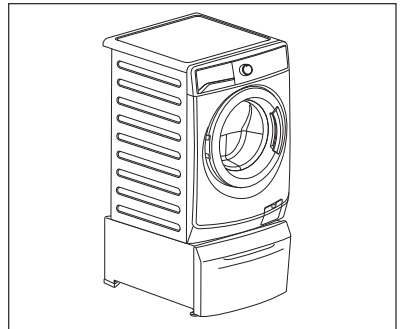

To put the appliance higher at the level what helps easy load and remove the laundry.

The drawer can be used for laundry storage e.g. towels, cleaning products and more.

Read carefully the instructions supplied with the accessory.

---



## 3. CONTROL PANEL

### 3.1 Control Panel Description

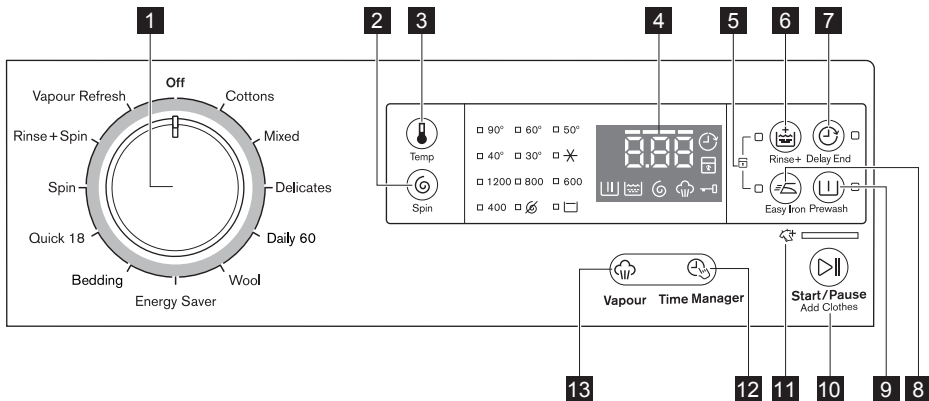

- |   |   |
|---|---|
| <b>1</b> Program Knob                   | <b>8</b> Easy Iron Touchpad                 |
| <b>2</b> Spin Selection Touchpad        | <b>9</b> Prewash Touchpad                   |
| <b>3</b> Temperature Selection Touchpad | <b>10</b> Start/Pause, Add Clothes Touchpad |
| <b>4</b> Display                        | <b>11</b> Add Clothes Function Symbol       |
| <b>5</b> Child Lock (see page 13)       | <b>12</b> Time Manager Touchpad             |
| <b>6</b> Rinse Plus Touchpad            | <b>13</b> Vapour Touchpad                   |
| <b>7</b> Delay End Touchpad             |   |

### 3.2 Display

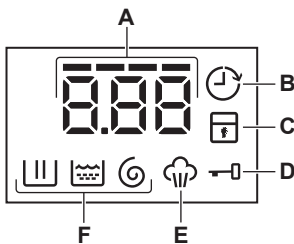

- |   |   |
|---|---|
| <b>A)</b> Digital Number;<br>will tell you:   | <b>B)</b> Delay End Icon                          |
| - Washing Cycle Time  | <b>C)</b> Child Lock Icon                         |
| - Delay End Time  | <b>D)</b> Door Lock Icon                          |
| - The alarm codes. Refer to the chapter<br>"Troubleshooting" for their description. | - It is on, you cannot open the door.             |
| - The level of the Time Manager<br>(----).  | - It is off, you can open the door.               |
|   | <b>E)</b> Vapour Icon                             |
|   | <b>F)</b> Washing Phase icon<br>(Wash/Rinse/Spin) |









### 3.3 Program Chart

| Program ;<br>Temperature<br>range           | Max. load<br>(Dry Clothes) ;<br>Max. Spin Speed |                       | Type of load and soil level  |
|---|---|-----------------------|--|
|   | Model   |                       |  |
|   | EWF12853  | EWF12753<br>EWF12753E |  |
| <b>Off</b>                                  | -   | -                     | This position to reset program/switching off the machine.  |
| <b>Cottons ;</b><br>* <sup>2)</sup> to 90°C | 8.5 kg ;<br>1200 rpm                            | 7.5 kg ;<br>1200 rpm  | White and coloured cotton. (Adjust wash time according to soil level. See Time Manager table on page 12)   |
| <b>Mixed ;</b><br>* to 60°C                 | 4 kg ;<br>1200 rpm                              | 3.5 kg ;<br>1200 rpm  | Synthetic or mixed fabric items. (Adjust wash time according to soil level. See Time Manager table on page 12)   |
| <b>Delicates ;</b><br>* to 40°C             | 4 kg ;<br>1200 rpm                              | 3.5 kg ;<br>1200 rpm  | Delicate fabrics such as acrylics, viscose, polyester items. (Adjust wash time according to soil level. See Time Manager table on page 12)                                       |
| <b>Daily 60 ;</b><br>30°C to 60°C           | 5.5 kg ;<br>1200 rpm                            | 3.5 kg ;<br>1200 rpm  | Coloured cotton e.g. shirts, blouses, towels and undergarments with normal level of soil.  |
| <b>Wool ;</b><br>* to 40°C                  | 2 kg ;<br>1200 rpm                              | 2 kg ;<br>1200 rpm    | Specially tested program for woollen garments bearing the "Pure new woollen, non-shrink, machine washable" label.  |
| <b>Energy Saver ;</b><br>40°C <sup>1)</sup> | 8.5 kg ;<br>1200 rpm                            | 7.5 kg ;<br>1200 rpm  | White and colourfast, cotton with normal soil. Set this program to have a good washing results and decrease the energy consumption. The time of the washing program is extended. |
| <b>Bedding ;</b><br>* to 60°C               | 3 kg ;<br>800 rpm                               | 3 kg ;<br>800 rpm     | Special program for one synthetic blanket, duvet, bedspread and so on. (Adjust wash time according to soil level. See Time Manager table on page 12)                             |
| <b>Quick 18 ;</b><br>30°C                   | 1.5 kg ;<br>800 rpm                             | 1.5 kg ;<br>800 rpm   | Lightly soiled synthetics or mixed fabrics.  |
| <b>Spin</b>                                 | 8.5 kg ;<br>1200 rpm                            | 7.5 kg ;<br>1200 rpm  | To spin the laundry and drain the water in the drum.   |
| <b>Rinse + Spin</b>                         | 8.5 kg ;<br>1200 rpm                            | 7.5 kg ;<br>1200 rpm  | To rinse and spin the laundry.   |
| <b>Vapour Refresh</b>                       | 1.5 kg ; Clothes tumble in vapour.              |                       | This cycle removes odours and helps to dewrinkle the laundry.<br> Do not add detergent.       |

1) Energy Saver program with 40degC option selected is recommended to wash a normally soiled cotton load at rated load capacity and is the water and energy rating label program.

2) Symbol " \* " represents Cold water.

### 3.4 Program Options Compatibility

| Program / Option | Spin  |  |  |  |  |  |  |  |
|------------------|---|--|---|---|---|---|---|--|
|                  | No Spin (  ) | Rinse Hold (  ) |   |   |   |   |   |  |
| Cottons          | ✓   | ✓  | ✓   | ✓   | ✓   | ✓   | ✓   | ✓  |
| Mixed            | ✓   | ✓  | ✓   | ✓   | ✓   | ✓   | ✓   | ✓  |
| Delicates        | ✓   | ✓  | ✓   | ✓   |   | ✓   | ✓   | ✓  |
| Daily 60         | ✓   | ✓  | ✓   | ✓   |   |   |   |  |
| Wool             | ✓   | ✓  |   | ✓   |   |   |   |  |
| Energy Saver     | ✓   | ✓  | ✓   | ✓   |   | ✓   | ✓   | ✓  |
| Bedding          | ✓   |  |   | ✓   |   |   | ✓   | ✓  |
| Quick 18         | ✓   | ✓  |   | ✓   |   |   |   |  |
| Spin             | ✓   |  |   | ✓   |   |   |   |  |
| Rinse + Spin     | ✓   | ✓  |   | ✓   |   |   |   |  |
| Vapour Refresh   |   |  |   | ✓   |   |   |   | ✓  |

1) Vapour option can be combined with temperature 40 to 90 °C only.

### 3.5 Options

#### Temperature Touchpad ( )

Press this touchpad repeatedly to increase or decrease the wash temperature if you want your laundry to be washed at a temperature different from the one proposed by the washing machine.

#### Spin Selection Touchpad ( )

Press this touchpad repeatedly to increase or decrease the spin speed or select Rinse Hold, if you want your laundry to be spun at a speed different from the one proposed by the washing machine.



- **No Spin** (  )

No spin option eliminates all the spin phases and increase the number of rinses.

- **Rinse Hold** (  )

By selecting this option the water of the last rinse is not emptied out and the drum turns regularly to prevent the laundry creases.

The door is still locked to indicate that the water must be emptied out.

 The door stays locked with the water in the drum. To continue the cycle you must press  (Start/Pause).

#### Rinse Plus Touchpad ( )

This option is recommended for people who are allergic to detergents, and in areas where the water is very soft. Press it to add two rinse phases to a program. The indicator of this option comes on.

#### Delay End Touchpad ( )

Before you start the program, this option makes it possible to define the end of the washing program from minimum 1 hour to maximum 19 hours.

 If program duration is longer than 3 hours minimum Delay End option starts from 4 hours.

Press the Delay End touchpad to choose the end time as your wish. The display shows the number of hours and the indicator beside the touchpad is on.

 **This option must be selected after choosing the wash program, and before pressing the “Start/Pause” touchpad.**

For example, if the program duration of your selected program is 3.20 hours and you define the “Delay End” time to 6 hours. This means your wash program will finish in 6 hours. (See diagram)

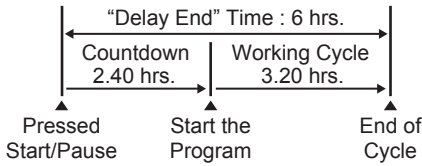

After selecting Delay End time, press Start/Pause touchpad to start the program. Machine will then countdown and update time on the display every hours until it reaches the starting point of the wash cycle.

If you wish to modify or cancel Delay End option after starting the program, follow the steps below:

- set the washing machine to PAUSE by pressing “Start/Pause” touchpad;
- deselect this option by pressing “Delay End” touchpad repeatedly till the display shows delay time “0”;
- press the “Start/Pause” to start the program.

### Easy Iron Touchpad ( )

When selecting this option the laundry is gently washed and spun to avoid creasing. In this way ironing is easier. The indicator of this option comes on.

### Prewash Touchpad ( )

Select this option if you wish your laundry to be pre-washed before the main wash. Use this option for heavy soil. The indicator of this option comes on.

When you set this function, put the detergent into the “  ” compartment.

This function increases the program duration.

### Time Manager ( )

This option allows you to adjust the wash time. Press this touchpad repeatedly to decrease or increase the wash time according to the soil level of your wash. Use the table below as a guide.

| Soil Level | Light | Medium | Normal | Heavy |
|------------|-------|--------|--------|-------|
| Wash Level | -     | --     | ---    | ----  |

### Vapour Touchpad ( )

Select this option to add approximately 30 minutes of tumbling in vapour during the wash cycle. Vapour helps open fabric fibers up to allow laundry additives to release tough stains. The indicator of this option comes on.

#### NOTE:

- Vapour may not necessarily be visible inside the drum during a vapour wash cycle. Vapour is created below the drum and allowed to naturally rise into the clothes.
- Vapour may not be present during the entire vapour wash cycle.
- Vapour function is more effective with half load.
- At the end of the Vapour cycle the clothes will be warmer, softer and detached from the drum.

 If Vapour option is selected, rinse temperatures will be elevated.

During a vapour cycle you may notice vapour exiting from the drain hose of the washing machine, this is normal and there is no cause for alarm.







## 3.6 Settings

### Child Safety Lock Option ( )

Your appliance is provided with CHILD SAFETY LOCK which permits you to leave the appliance unsupervised with the door closed without having to worry that children might be injured by or cause damage to the appliance.

 **Set this option after pressing the Start/Pause touchpad.**

#### To set “Child Lock” option:

- To activate the function, press “Rinse + (  ) and Easy Iron (  )” touchpads at the same time until the display shows the symbol “  ”.
- To deactivate the function, press “Rinse + (  ) and Easy Iron (  )” touchpads at the same time until the symbol “  ” goes off.

 This function remains enabled even after the appliance is switched off.

### Enabling/Disabling End-Of-Wash Buzzer

This setting permits you to either enable or disable the buzzer at the end of the program. As an example, you might wish to disable this buzzer when you start a wash when going to bed, so that when the wash finished approximately 1 hour later, it will not disturb you through the night.

**i** Error warning beeps such as critical faults are not disabled.

To disable the buzzer sound, press “Easy Iron (≠) and Prewash (⏏)” touchpads at the same time for 3 seconds, and listen for “BEEP, BEEP”.

To return to default configuration press these 2 touchpads at the same time for 3 seconds, and listen for “BEEP”.

### 3.7 Start/Pause (▷||) and Add Clothes (↻) Touchpad

This touchpad has 2 functions:

- **Start/Pause (▷||):**

After you have selected the desired program and options, press this touchpad to start the machine. The Start/Pause pilot light will stop flashing and remain lit until the water level is above the bottom edge of the door then pilot light goes OFF. If you have selected a “Delay End” option, the countdown will begin and will be shown on the display.

To interrupt a program which is running, press this touchpad to pause the machine, the Start/Pause pilot light flashes.

To restart the program from the point at which it was interrupted, press this touchpad again, the Start/Pause pilot light will stop flashing.

- **Add Clothes (↻):**

**i** You can only add clothes if “Start/Pause” pilot light is lit.

While running a program, you may add clothes by:

- Pressing the “Start/Pause” touchpad to pause the program.
- Wait for the machine to come to a complete stop before opening the door.
- Add clothing and close the door.
- Resume the program by pressing “Start/Pause” touchpad again.

## 4. BEFORE FIRST USE

**i** **NOTE**

**During installation or before first use you may observe some water in the machine. This is a residual water left in the machine after a full functional test in the factory to ensure the machine is delivered to customers in perfect working order and is no cause for concern.**

1. Ensure that the electrical and water connections comply with the installation instructions.

2. Put 2 litres of water in the detergent compartment for washing phase. This activates the drain system.
3. Select a Cottons cycle at 90 °C, without any laundry in the machine, to remove any manufacturing residue from the drum and tub then start the machine.

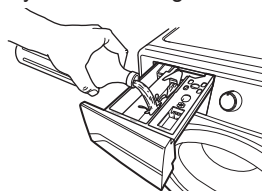

## 5. DAILY USE

### 5.1 Loading The Laundry

1. Turn the water tap on.
2. Connect the mains plug to the mains socket.
3. Turn the knob to set a program. The washing machine will propose a temperature and automatically select the spin value provided for the program you have chosen.

The selector knob can be turned either clockwise or anticlockwise.

Position "Off" to reset program/ switching OFF the machine.

At the end of the program the selector dial must be turned to position "Off", to switch the machine off.

4. Check and remove objects (if there are any) that could be trapped in the fold.

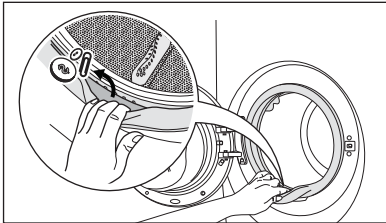

5. Place the laundry in the drum, one item at a time, shaking them out as much as possible. (Refer to page 18 "WASHING HINTS")
6. Close the door.



#### CAUTION

Make sure that no laundry remains between the seal and the door.

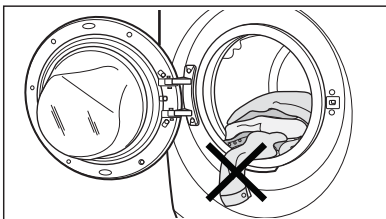

### 5.2 Using Detergent And Additives





**IMPORTANT:** Please read "Detergents Type and Quantity of Detergents" on page 19 before use.

1. Detergent Dispenser Drawer

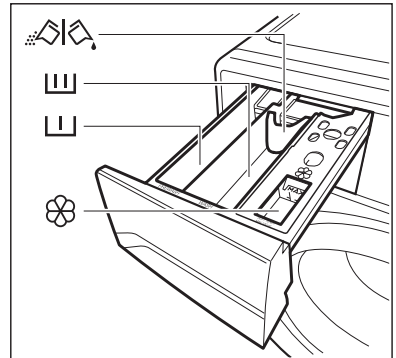
The detergent dispenser is divided into three compartments.



-  Compartment "MAIN WASH"  
This compartment is used for detergent on all programs.
-  Compartment "PREWASH"  
This compartment is only used for detergent when a Prewash is selected.
-  Compartment "SOFTENER"  
This compartment is used for fabric conditioner and starching agent.



Detergent flap

Flap for powder or liquid detergent.



- **Position down** : for liquid detergent.
- **Position up** : for powder detergent (factory setting).

- i** Depending on your model you may need to remove the dispenser drawer to change flap position.

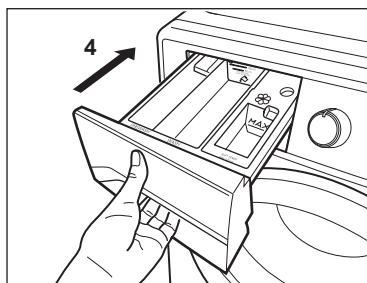
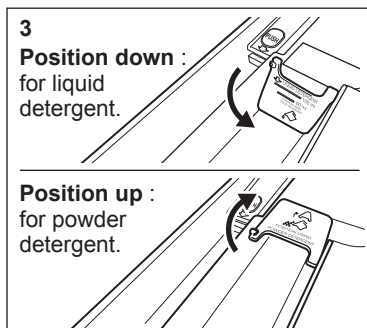
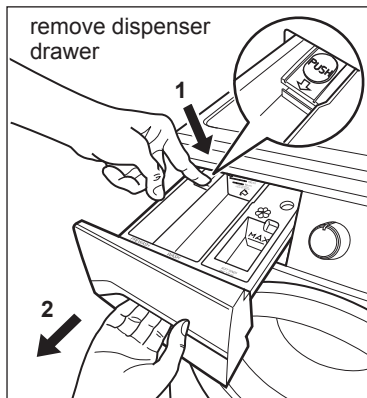



- i** **When you use the liquid detergent:**

- Do not use gelatinous or thick liquid detergents.
- Do not put more liquid than the maximum level.
- Do not set the "Prewash" phase.
- Do not set the "Delay End".

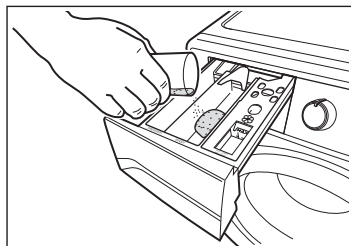
2. Measure out the detergent and the fabric softener;
- Pull out the dispenser drawer until it stops.
  - Measure out the amount of detergent required, pour it into the main wash compartment.



- If you wish to carry out the "Prewash" phase, pour it into the compartment marked .
- If required, pour fabric softener into the compartment marked .

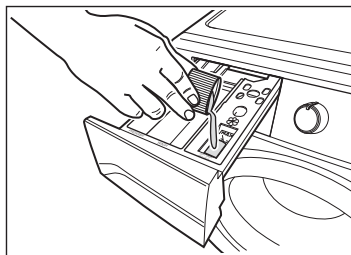



- i** The amount used must not exceed the "MAX" mark in the drawer.

If you use thick softeners it is recommended to dilute with water.

- Close the drawer gently.
- i** Residues of detergent, softener and water may remain in the dispenser. It is recommended to clean the dispenser regularly to remove any residue.

### 5.3 Options Setting

1. If you want your laundry to be spun or use temperature different from the one proposed by the washing machine, press the Spin  and the temperature  touchpads repeatedly to change the spin speed and temperature.

Press the option touchpads, if you want your laundry to be washed with special functions.

 - Different functions can be combined which is dependent on the program selected.

- If an option is not compatible with the wash program selected, symbol “ --- ” will flash on display along with buzzer sound.

2. If you want to adjust washing time, press the “Time Manager (⌚)” touchpad repeatedly to increase or decrease washing time. See Time Manager guide on page 12.

If you want to define the end of the washing program, press the “Delay End (⌚)” touchpad repeatedly to choose your washing machine working time.

## 5.4 Starting A Cycle (▷||)

To start a program, press the Start/Pause touchpad. The corresponding pilot light will stop flashing and a default program duration will be displayed on the screen.

- If you press any touchpad while a program is operating, symbol “ --- ” will flash on display along with buzzer sound. (except Start/Pause touchpad)
- If you turn the program selector knob to another program when the machine is working (except “Off” to switch off the machine), symbol “ --- ” will flash on display along with buzzer sound to indicate a wrong selection. The machine will not perform the new selected program.

 After approx. 15 minutes from the start of a program:

- The appliance will automatically adjust the selected program duration according to the type and size of the load.
- The display will show adjusted program duration.

## 5.5 Interruption Of A Program

- To pause press Start/ Pause. The indicator will start flashing.
- Press the Start/Pause again. The program will continue.

## 5.6 Changing A Program

Changing a running program is possible only by resetting it.

- Turn the program selector knob to the position “Off” to cancel the program and to turn off the appliance.
- Turn the program selector knob to the new program position and change any available options. Press Start/Pause to start the new program.



 The appliance will not drain the water (except programs; Spin, Rinse + Spin, Vapour Refresh).

## 5.7 Changing The Options

It may be possible to change some of the options after a wash program has started.

1. Press the touchpad Start/Pause. The indicator will start flashing.
2. If available change the options that you wish.
3. Press Start/Pause again. The program will continue.

## 5.8 Opening The Door

While a program or the Delay End is operating, the appliance door is locked and the display shows the indicator “  ”. First set the machine to PAUSE by pressing the “Start/Pause” touchpad. Wait until the door lock indicator “  ” goes off, then the door can be opened.

If the door lock indicator “  ” does not disappear, this means that the machine is already heating and the water level is above the bottom edge of the door or the drum is turning. In this case the door CAN NOT be opened. If you need to open it, you must drain the water to open the door.



**In case of emergency please refer to “Emergency door opening” on page 27.**



## 5.9 At The End Of The Program

- The appliance stops automatically.
- The acoustic signal will operate.
- The display will show “0”.
- The indicator of the touchpad Start/Pause goes off.
- The door lock indicator “ ” goes off.
- Remove the laundry from the appliance. Make sure that the drum is empty.
- Keep the door ajar, to prevent the mildew and odours.
- Turn off the water tap.

 At the end of the program the time remaining can suddenly decrease from 7 minutes or less to 0 due to the overestimated total program time during the load sensing phase. In some cases (with perfectly balanced load) the program time can be shorter than the time estimated after the load sensing phase is completed. This is a normal behavior of the machine and not a cause for concern as it does not compromise its performance.

## 5.10 When The Washing Program Is Completed, But There Is Water In The Drum (Option “Rinse Hold” is used)

- The drum turns regularly to prevent the creases in the laundry.
- The indicator “Start/Pause” flashes to remind you to drain the water.
- The door lock indicator “ ” is on. The door stays locked.

You must drain the water to open the door.

### To drain the water:

1. Press the “Start/Pause  ” touchpad. The appliance drains the water and spins with the maximum spin speed for selected program.

**Alternatively**, before pressing the “Start/Pause” touchpad, you can press the “Spin  ” touchpad to change the spin speed. You can select “No Spin”, if you want the machine to only drain the water.

2. When the program is completed and the door lock indicator “ ” goes off, you can open the door.
3. turn the program selector knob to the position “Off” to deactivate the appliance.

### NOTE:

After approximately 18 hours if you do not press Start/Pause touchpad, the appliance will drain and spin automatically (except for “Wool” program) .

## 5.11 AUTO Standby Function

The AUTO Standby mode automatically deactivates the appliance to decrease the energy consumption when:

- You do not press any buttons for 5 minutes before you press “Start/Pause”.
  - All indicators and the display will switch off.
  - The indicator of the touchpad Start/Pause will flash slowly.

 Press any touchpad to reactivate the appliance.

- 5 minutes after the washing program ends, if you do not deactivate the appliance, the energy saving function activates.
  - All indicators and the display will switch off.
  - The indicator of the touchpad Start/Pause will flash slowly.

 Press any touchpad to reactivate the appliance.

- Display will show the end of the last wash.
- Press any touchpad again to show the last wash program.
- Turn the selector knob to set a new wash program.

## 6. WASHING HINTS

### 6.1 Sorting The Laundry

Follow the wash code symbols on each garment label and the manufacturer's washing instructions. Sort the laundry as follows: whites, coloureds, synthetics, delicates, woollens.

### 6.2 Temperatures

|                      |   |
|----------------------|---|
| 90°C                 | For normally soiled white cottons and linen (e.g. tea cloths, towels, tablecloths, sheets...).  |
| 60°C<br>50°C         | For normally soiled, colourfast garments (e.g. shirts, night dresses, pyjamas....) in linen, cotton or synthetic fibres and for lightly soiled white cotton (e.g. underwear). |
| 40°C<br>30°C<br>Cold | For delicate items (e.g. net curtains), mixed laundry including synthetic fibres and woollens bearing the label pure new wool, machine washable, non-shrink.                  |

### 6.3 Before Loading The Laundry

- Make sure that no metal objects are left in the laundry (e.g. hair clips, safety pins, pins).
- Button up pillowcases, close zip fasteners, hooks and poppers. Tie any belts or long tapes.
- Wash bras, pantyhose and other delicates in a mesh laundry bag, which you can purchase from your supermarket.

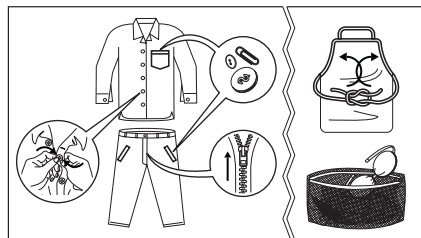

- Make sure that you wash lint collectors separately from lint producers.

- Never wash whites and coloureds together. Whites may lose their "whiteness" in the wash.
- New coloured items may run in the first wash; they should therefore be washed separately the first time.
- Remove persistent stains before washing.
- Rub particularly soiled areas with a special detergent or detergent paste. Treat curtains with special care. Remove hooks or tie them up in a bag or a net.

### 6.4 Maximum Loads

Recommended loads are indicated in the program charts. General rules:

|                                |                                       |
|--------------------------------|---------------------------------------|
| Cotton, linen:                 | drum full but not too tightly packed; |
| Synthetics:                    | drum no more than half full;          |
| Delicate fabrics and woollens: | drum no more than one third full.     |

Washing a maximum load makes the most efficient use of water and energy. For heavily soiled laundry, reduce the load size.

### 6.5 Removing Stains

Stubborn stains may not be removed by just water and detergent. It is therefore advisable to treat them prior to washing.

**Blood:** treat fresh stains with cold water. For dried stains, soak overnight in water with a special detergent then rub in the soap and water.

**Oil based paint:** moisten with benzine stain remover, lay the garment on a soft cloth and dab the stain; treat several times.

**Dried grease stains:** moisten with turpentine, lay the garment on a soft surface and dab the stain with the fingertips and a cotton cloth.

**Rust:** oxalic acid dissolved in hot water or a rust removing product used in cold water. Be careful with rust stains which are not recent since the cellulose structure will already have been damaged and the fabric tends to hole.

**Mould stains:** treat with bleach, rinse well (whites and fast coloureds only).

**Grass:** soap lightly and treat with bleach (whites and fast coloureds only).

**Ball point pen and glue:** moisten with acetone (\*), lay the garment on a soft cloth and dab the stain.

**Lipstick:** moisten with acetone (\*) as above, then treat stains with methylated spirits. Remove any residual marks from white fabrics with bleach.

**Red wine:** soak in water and detergent, rinse and treat with acetic or citric acid, then rinse. Treat any residual marks with bleach.

**Ink:** depending on the type of ink, moisten the fabric first with acetone (\*), then with acetic acid; treat any residual marks on white fabrics with bleach and then rinse thoroughly.

**Tar stains:** first treat with stain remover, methylated spirits or benzine, then rub with detergent paste.

(\*) do not use acetone on artificial silk.

## 6.6 Detergents Type And Quantity Of Detergent

Low sudsing detergent is required for this washing machine to prevent oversudsing problems, unsatisfied washing result and harm to the machine. Low sudsing detergents designed for front load washing machines are labelled "Front Loading", "high efficiency", "HE", such as Cold Power for Front Loaders or "Matic".

**Do not use wrong types of detergent, such as Top Loading, Handwash detergent or Soap-Based products in your frontload washing machine. This can result in excessive suds, longer cycle time, low spin speeds, poor rinsing and overloading of the motor.**

### Quantity of detergent to be used

The choice of detergent and use of correct quantities not only affects your wash performance, but also helps to avoid waste and protect the environment. Although biodegradable, detergents contain substances which in large quantities can upset the delicate balance of nature.

The choice and quantity of detergent will depend on ;

- type of fabric (delicates, woollens, cottons, etc.) ;
- the colour of clothes ;
- size of the load ;
- degree of soil ;
- wash temperature ; and
- hardness of the water used.

Water hardness is classified by so-called "degrees" of hardness.

Information on hardness of the water in your area can be obtained from the relevant water supply company, or from your local authority.

You may have to try using the detergent quantity as per manufacturers' instructions then compare the wash result to the list below and adjust the amount of detergent for your future washes accordingly.

### Not enough washing powder causes:

- the washload to turn grey,
- greasy clothes.

### Too much washing powder causes:

































- sudsing,
- reduced washing effect,
- inadequate rinsing.

### Use less detergent if:

- you are washing a small load,
- the laundry is lightly soiled,
- large amounts of foam during washing.

## 7. INTERNATIONAL WASH CODE SYMBOLS

 These symbols appear on fabric labels, in order to help you choose the best way to treat your laundry.

|  |   |  |   |  |  |  |
|--|---|--|---|--|--|--|
| <br><b>Energetic wash</b> | <br>Max. wash temperature 95 °C  | <br>Max. wash temperature 60 °C   | <br>Max. wash temperature 40 °C  | <br>Max. wash temperature 30 °C | <br>Hand wash       | <br>DO NOT wash at all |
| <br><b>Delicate wash</b>  |   |   |   |                                 |  |  |
| <br><b>Bleaching</b>      | <br>Bleach in cold water         |  |   | <br>DO NOT bleach               |  |  |
| <br><b>Ironing</b>        | <br>Hot iron max. 200 °C         | <br>Warm iron max. 150 °C   | <br>Lukewarm iron max. 110 °C  | <br>DO NOT iron                 |  |  |
| <br><b>Dry cleaning</b>   | <br>Dry cleaning in all solvents | <br>Dry cleaning in perchlorethylene, petrol, pure alcohol, R 111 & R 113 | <br>Dry cleaning in petrol, pure alcohol and R 113                                 | <br>DO NOT dry clean            |  |  |
| <br><b>Drying</b>         | <br>Flat                         | <br>On the line   | <br>On clothes hanger  | <br>High temperature            | <br>Low temperature | <br>DO NOT tumble dry  |

## 8. CARE AND CLEANING

 **WARNING!** You must DISCONNECT the appliance from the electricity supply, before you can carry out any cleaning or maintenance work.

### 8.1 External Cleaning

Clean the appliance only with soap and warm water. Fully dry all the surfaces.

 **CAUTION! Do not use alcohol, solvents or chemical products.**

### 8.2 Descaling

The water we use normally contains lime. It is a good idea to periodically use a water softening powder in the machine.

Do this separately from any laundry washing, and according to the softening powder manufacturer's instructions.

This will help to prevent the formation of lime deposits.

### 8.3 After Each Wash

Leave the door open for a while. This helps to prevent mould and stagnant smells forming inside the appliance.

Keeping the door open after a wash will also help to preserve the door seal.

## 8.4 Maintenance Wash

With the use of low temperature washes it is possible to get a build up of residues inside the drum.

We recommend that a maintenance wash be performed on a regular basis.

### To run a maintenance wash:

- The drum should be empty of laundry.
- Select the hottest cotton wash program.
- Use a normal measure of detergent, must be a powder with biological properties.

## 8.5 Cleaning The Dispenser Drawer

The washing powder and additive dispenser drawer should be cleaned regularly. Remove the drawer by pressing the catch downwards and by pulling it out. Flush it out under a tap, to remove any traces of accumulated powder.

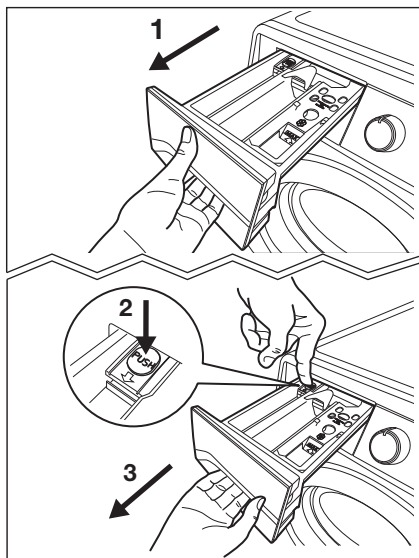

To aid cleaning, the top part of the additive compartment should be removed.

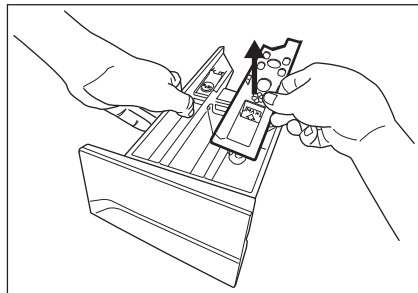

## 8.6 Cleaning The Drawer Recess

Having removed the drawer, use a small brush to clean the recess, ensuring that all washing powder residue is removed from the upper and lower part of the recess. Replace the drawer and run the rinse program without any clothes in the drum.

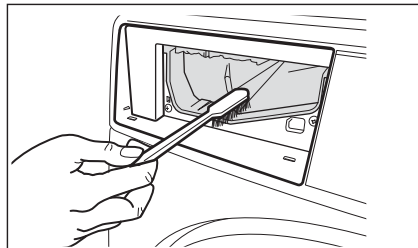

## 8.7 Cleaning The Pump

**i** Regularly examine the drain pump and make sure that it is clean.

Clean the pump if:

- The appliance does not drain the water.
- The drum cannot turn.
- The appliance makes an unusual noise because of the blockage of the drain pump.
- The display shows an alarm code because of the problem with water drain.

**!** **WARNING!**

1. Disconnect the mains plug from the mains socket.

2. Do not remove the filter while the appliance is operating. Do not clean the drain pump if the water in the appliance is hot. The water must be cold before you clean the drain pump.

**To clean the drain pump:**

1. Open the drain pump door.

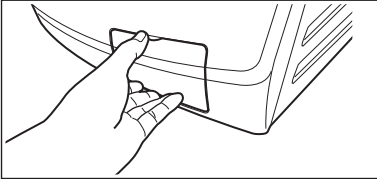

2. Pull the flap down, then squeeze the legs on both sides of the cover together and pull out (as picture).

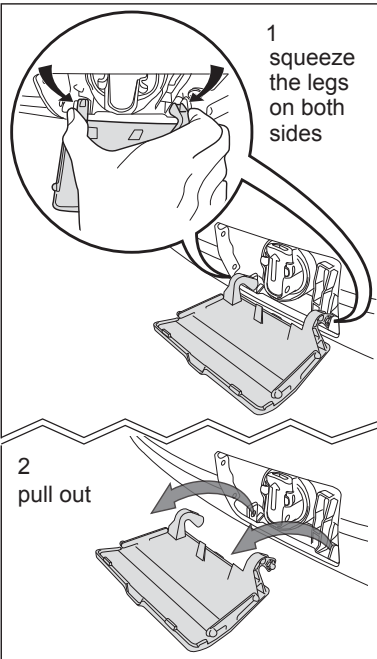
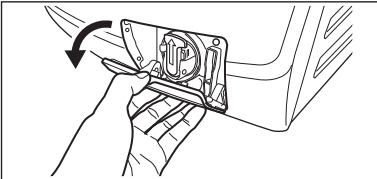

3. Place a suitable water container below the recess of the drain pump to collect the water that flows out.

Press the two levers and pull forward the drainage duct to let the water flow out.

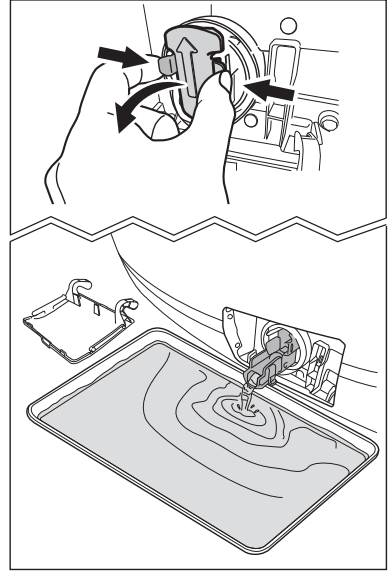

4. When the container is full of water, put the drainage duct back again and empty the container. Do step 3 again and again until no more water flows out from the drain pump.

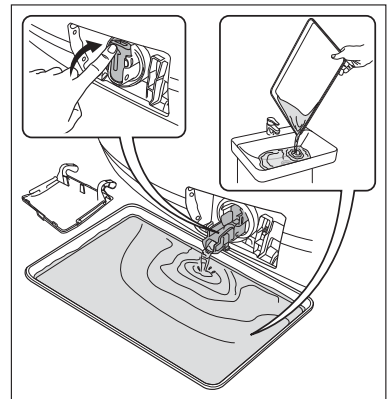

5. Pull back the drainage duct and turn the filter counter-clockwise to remove it.

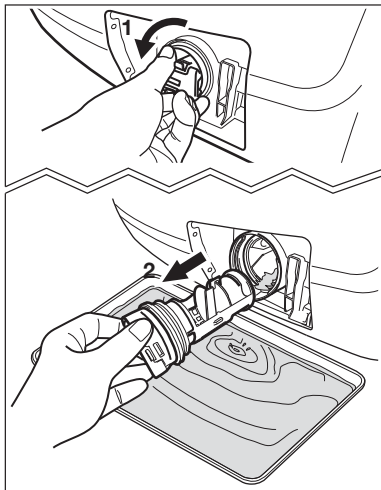

6. Remove fluff and objects from the pump (if there are any).

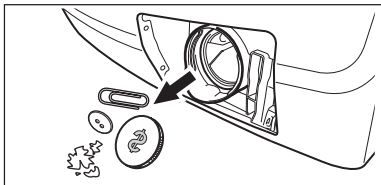

7. Make sure that the impeller of the pump can turn. If this does not occur, contact the service centre.

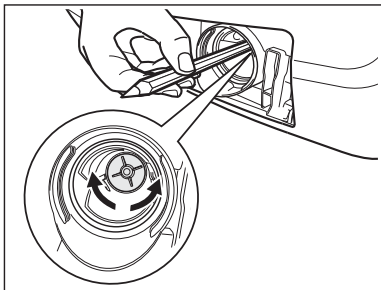

8. Clean the filter under the water tap.

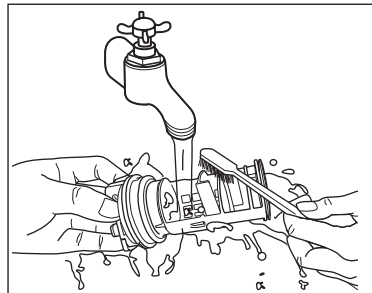

9. Put the filter back in the pump into the special guides. Make sure that you correctly tighten the filter to prevent leakages.

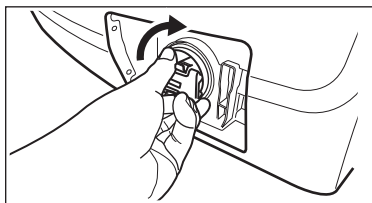

10. Put the flap back and close the drain pump door.

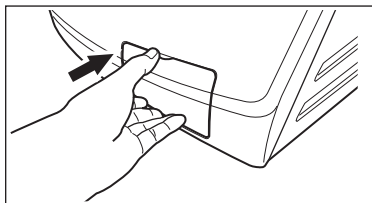

## 8.8 Cleaning The Water Inlet Filter

If your water is very hard or contains traces of lime deposit, the water inlet filter may become clogged. It is therefore a good idea to clean it from time to time.

### To clean the water inlet filters:

1. Close the water tap.
2. Remove the water inlet hose from the water tap.
3. Clean the filter in the inlet hose with a stiff brush.

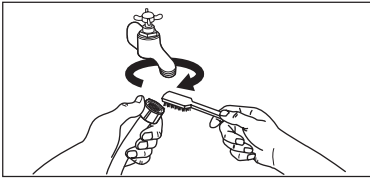

4. Remove the inlet hose behind the appliance.
5. Clean the filter in the valve with a stiff brush or a towel.

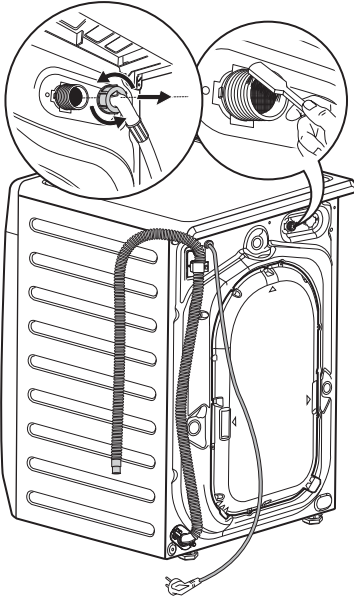

6. Install the inlet hose again. Make sure that the couplings are tight to prevent leakages.

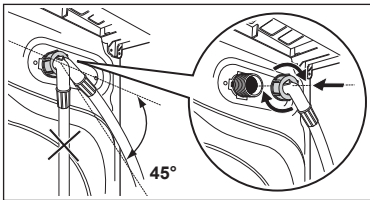

7. Open the water tap.

### 8.9 Frost Precautions

If the appliance is installed in an area where the temperature can be less than 0 °C, remove the remaining water from the inlet hose and the drain pump.

### Emergency Drain

1. Disconnect the mains plug from the mains socket. Turn off the water tap.
2. Remove the water inlet hose.
3. Remove the drain hose from the rear support and unhook it from sink or spigot.

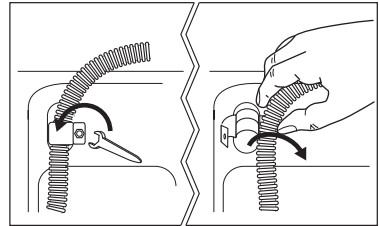

4. Put the ends of the drain and inlet hose in a container. Let the water flow out of the hoses.

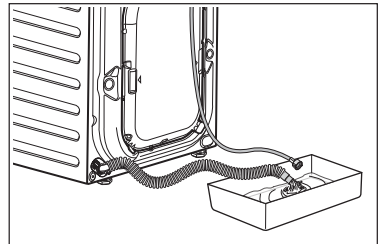

5. When no more water flows, install the inlet hose and the drain hose again.

**!** **NOTE**

Make sure that the temperature is more than 0 °C before you use the appliance again.



## 9. TROUBLESHOOTING

### 9.1 Possible Failures

Certain problems are due to lack of simple maintenance or oversights, which can be solved easily without calling out an engineer. Before contacting your local Service Centre, please carry out the checks listed below.

Once the problem has been eliminated, press the Start/Pause button to restart the program. If after all checks, the problem persists, contact your local Service Centre.



**WARNING!** Deactivate the appliance before you do the checks.

#### Alarm Code:

|            |  |
|------------|--|
| <b>E10</b> | The appliance does not fill with water properly.   |
| <b>E20</b> | The appliance does not drain the water.  |
| <b>E40</b> | The appliance door is open or not closed correctly. Please check the door!                     |
| <b>E40</b> | The mains supply is unstable. Wait until the mains supply is stable.                           |
| <b>E91</b> | No communication between electronic elements of the appliance. Switch off and switch on again. |

| Malfunction  | Possible cause => Solution   |
|--|--|
| <b>The washing machine does not start:</b>         | • The door has not been closed. (Error code: E40) => Close the door firmly.  |
|  | • The plug is not properly inserted in the power socket. => Insert the plug into the power socket.   |
|  | • There is no power at the socket. => Please check your domestic electrical installation.  |
|  | • The Start/Pause touchpad has not been pressed. => Press the Start/Pause touchpad.  |
|  | • The "Delay End" has been selected. => If the laundry are to be washed immediately, cancel the "Delay End".                                 |
|  | • The Main supply is unstable. (If E40 appears in the display.) => Wait until the main supply is stable. Appliance will start automatically. |
| <b>The machine does not fill the water:</b>        | • The water tap is closed. (Error code: E10) => Open the water tap.  |
|  | • The inlet hose is squashed or kinked. (Error code: E10) => Check the inlet hose connection.  |
|  | • The filter in the inlet hose is blocked. (Error code: E10) => Clean the water inlet hose filter.   |
|  | • The door is not properly closed. (Error code: E40) => Close the door firmly.   |
| <b>The machine fills then empties immediately:</b> | • The end of the drain hose is too low. (Error code: E10) => Refer to relevant paragraph in "water drainage" section.                        |

| Malfunction   | Possible cause => Solution   |
|---|--|
| <b>The machine does not empty and/or does not spin:</b> | <ul style="list-style-type: none"> <li>• The drain hose is squashed or kinked. (Error code: E20) =&gt; Check the drain hose connection.</li> </ul>   |
|   | <ul style="list-style-type: none"> <li>• The drain pump is clogged. (Error code: E20) =&gt; Clean the drain filter.</li> </ul>   |
|   | <ul style="list-style-type: none"> <li>• The option "Rinse Hold" has been selected. =&gt; Press Start/Pause touchpad to drain the water or select spin program.</li> </ul>   |
|   | <ul style="list-style-type: none"> <li>• The laundry is not evenly distributed in the drum. =&gt; Pause the machine and redistribute laundry manually.</li> </ul>  |
| <b>There is water on the floor:</b>                     | <ul style="list-style-type: none"> <li>• Too much detergent or unsuitable detergent (creates too much foam) has been used. =&gt; Reduce detergent quantity and use correct type of detergent (refer page 19).</li> </ul>   |
|   | <ul style="list-style-type: none"> <li>• Check whether there are any leaks from one of the inlet hose fittings. It is not always easy to see this as the water runs down the hose; check to see if it is damp. =&gt; Check the water inlet hose connection.</li> </ul> |
|   | <ul style="list-style-type: none"> <li>• The drain hose is damaged. =&gt; Call Service.</li> </ul>   |
| <b>Unsatisfactory washing results:</b>                  | <ul style="list-style-type: none"> <li>• Too little detergent or unsuitable detergent has been used. =&gt; Increase detergent quantity or use different detergent (refer page 19).</li> </ul>  |
|   | <ul style="list-style-type: none"> <li>• Stubborn stains have not been treated prior to washing. =&gt; Use commercial products to treat the stubborn stains.</li> </ul>  |
|   | <ul style="list-style-type: none"> <li>• The correct temperature was not selected. =&gt; Check if you have selected the correct temperature.</li> </ul>  |
|   | <ul style="list-style-type: none"> <li>• Excessive laundry load. =&gt; Reduce load.</li> </ul>   |
| <b>The door will not open:</b>                          | <ul style="list-style-type: none"> <li>• The program is still running. =&gt; Wait until the end of cycle.</li> </ul>   |
|   | <ul style="list-style-type: none"> <li>• There is water in the drum. =&gt; You must drain the water to open the door (refer "Opening The Door" on page 16).</li> </ul>   |
|   | <ul style="list-style-type: none"> <li>• This problem may be caused by a failure of the appliance. =&gt; Contact Service. If you need to open the door, please read carefully "Emergency door opening" on next page.</li> </ul>  |
| <b>The machine vibrates or is noisy:</b>                | <ul style="list-style-type: none"> <li>• The transit bolts and packing have not been removed. =&gt; Check the correct installation of the appliance.</li> </ul>  |
|   | <ul style="list-style-type: none"> <li>• The support feet have not been adjusted. =&gt; Check the correct levelling of the appliance.</li> </ul>   |
|   | <ul style="list-style-type: none"> <li>• The laundry is not evenly distributed in the drum. =&gt; Pause the machine and redistribute laundry manually.</li> </ul>  |
|   | <ul style="list-style-type: none"> <li>• There is very little laundry in the drum. =&gt; Load more laundry.</li> </ul>   |
|   | <ul style="list-style-type: none"> <li>• Unstable floors eg. wooden floors. =&gt; Refer to relevant paragraph in "Positioning" section.</li> </ul>   |
| <b>Cycle time longer than displayed:</b>                | <ul style="list-style-type: none"> <li>• Detergent over dose. =&gt; Reduce the detergent quantity or use another one. (Refer page 19 "Detergents Type And Quantity Of Detergent").</li> </ul>  |
|   | <ul style="list-style-type: none"> <li>• Machine unbalance. =&gt; Redistribute laundry manually in the drum and start the spin phase again.</li> </ul>   |

| Malfunction   | Possible cause => Solution   |
|---|--|
| <b>The cycle is shorter than the time displayed.</b>      | <ul style="list-style-type: none"> <li>The appliance calculated a new time according to the laundry load.</li> </ul>   |
| <b>Spinning starts late or the machine does not spin:</b> | <ul style="list-style-type: none"> <li>The electronic unbalance detection device has cut in because the laundry is not evenly distributed in the drum. The laundry is redistributed by reverse rotation of the drum.<br/>This may happen several times before the unbalance disappears and normal spinning can resume. If, after 10 minutes, the laundry is still not evenly distributed in the drum, the machine will not spin. In this case, redistribute the load manually and select the spin program.<br/>=&gt; Pause the machine and redistribute laundry manually.</li> </ul> |
| <b>The machine makes an unusual noise:</b>                | <ul style="list-style-type: none"> <li>Machine not installed properly. =&gt; Make sure the levelling of the appliance is correct. Refer to "Installation".</li> </ul>  |
|   | <ul style="list-style-type: none"> <li>Transit bolts or packaging not removed. =&gt; Make sure that the packaging and/or the transit bolts are removed. Refer to "Unpacking".</li> </ul>   |
|   | <ul style="list-style-type: none"> <li>The load may be too small. =&gt; Add more laundry in the drum.</li> </ul>   |
| <b>No water is visible in the drum:</b>                   | <ul style="list-style-type: none"> <li>Machines based on modern technology operate very economically using very little water without affecting performance.</li> </ul>   |

## 9.2 Emergency Door Opening

In case of power failure or appliance failure the appliance door remains locked. The wash program continues when power is restored. If the door remains locked in case of failure, it is possible to open it using the emergency unlock feature.

**Before opening the door:**



**WARNING!**

**Make sure that the water temperature and the laundry are not hot. Wait till they cool down if necessary.**



**WARNING!**

**Make sure that the drum is not rotating. Wait till the drum stops rotating if necessary.**



**WARNING!**

**Make sure that the water level inside the drum is not too high. If necessary perform an Emergency Drain (see page 24).**

**To open the door proceed as follows:**

1. Turn the program selector dial to “Off” switch the appliance off.
2. Disconnect the mains plug from the mains socket.
3. Open the filter flap.
4. While pulling the emergency unlock strap (red strap) downward pull the door handle to open the door.

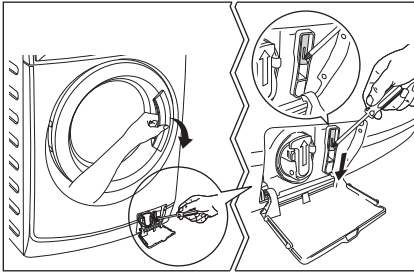

5. Take out the laundry.
6. Close the filter flap.

**i** If you are unable to identify or solve the problem, contact our service centre.

Before telephoning, make a note of the model, serial number and purchase date of your machine: the Service Centre will require this information.

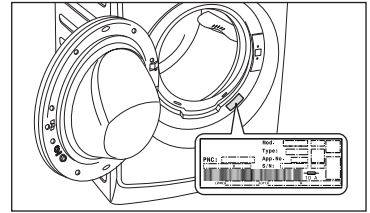

## 10. TECHNICAL DATA

|   |                            |                       |        |
|---|----------------------------|-----------------------|--------|
| Dimensions<br>(Height / Width / Depth)    | Model: EWF12853            | 85 X 60 X 66.9 cm     |        |
|   | Model: EWF12753, EWF12753E | 85 X 60 X 58.5 cm     |        |
| Power supply (Voltage / Frequency)        | 220-240 V / 50 Hz          |                       |        |
| Total power absorbed                      | 2100 W                     |                       |        |
| Minimum fuse protection                   | 10 A                       |                       |        |
| Water supply pressure (Maximum / Minimum) | 0.8 MPa / 0.05 MPa         |                       |        |
| Maximum dry clothes capacity              | EWF12853                   | EWF12753<br>EWF12753E |        |
|   | Cottons                    | 8.5 Kg                | 7.5 Kg |
|   | Mixed                      | 4 Kg                  | 3.5 Kg |
|   | Delicates                  | 4 Kg                  | 3.5 Kg |
|   | Daily 60                   | 5.5 Kg                | 3.5 Kg |
|   | Wool                       | 2 Kg                  | 2 Kg   |
|   | Energy Saver               | 8.5 Kg                | 7.5 Kg |
|   | Bedding                    | 3 Kg                  | 3 Kg   |
|   | Quick 18                   | 1.5 Kg                | 1.5 Kg |
|   | Spin                       | 8.5 Kg                | 7.5 Kg |
| Rinse + Spin                              | 8.5 Kg                     | 7.5 Kg                |        |
| Vapour Refresh                            | 1.5 Kg                     | 1.5 Kg                |        |
| Spin speed (Maximum / Minimum)            | 1200 rpm / 400 rpm         |                       |        |

# 11. INSTALLATION

## 11.1 Unpacking

### CAUTION!

All transit bolts and packing must be removed before using the appliance.

You are advised to keep all transit devices so that they can be refitted if the machine ever has to be transported again.

1. Use gloves. Remove the external film. If necessary, use a cutter.

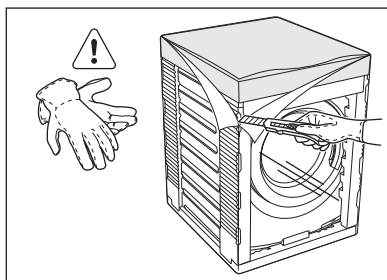

2. Remove the cardboard top.
3. Remove the polystyrene packaging materials.
4. Remove the plastic bag which cover the machine.

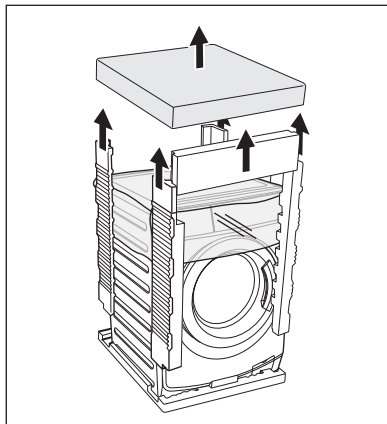

5. Open the door. Remove the polystyrene piece from the door seal and all the items from the drum.

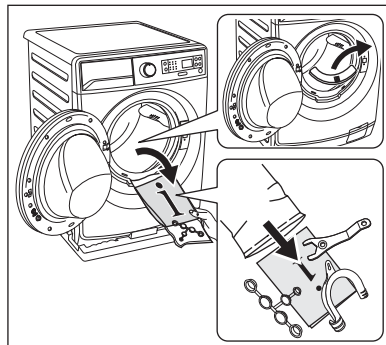

6. Put one of the polystyrene packaging elements on the floor behind the appliance. Carefully put down the appliance with the rear side on it. Make sure not to damage the hoses.

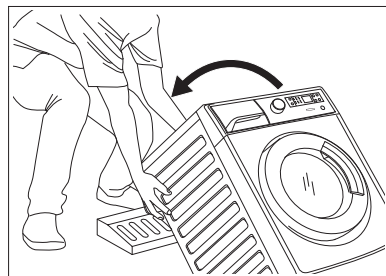

7. Remove the polystyrene base.
8. Pull up the appliance in vertical position.

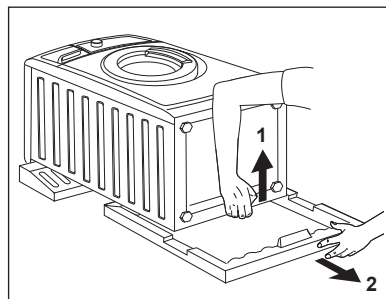

9. Remove the power supply cable and the drain and inlet hoses from the hose holders (A) on the rear of the appliance.

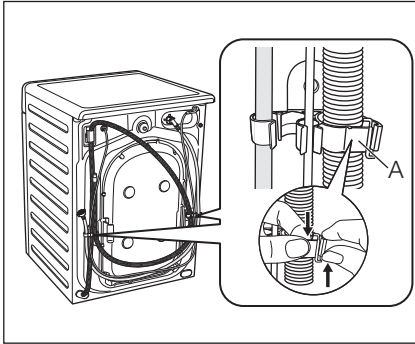

10. Remove the three transit bolts. Use the key supplied with the appliance.
11. Pull out the plastic spacers.

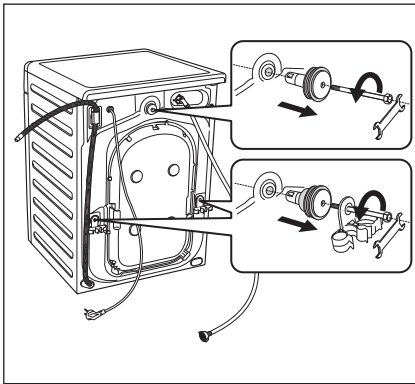

12. Put the plastic caps in the holes. You can find these caps in the user manual bag.

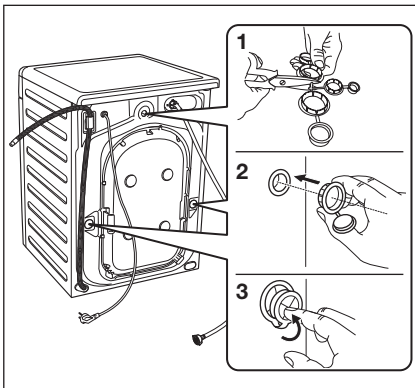

## 11.2 Positioning

It is important that your washing machine stands firm and leveled on the floor to ensure correct operation. The appliance must not be installed behind a lockable door, a sliding door or a door with a hinge on the opposite side to avoid restricting the washing machine door.

Use a spirit level on the top and side of the washing machine to check the levels.

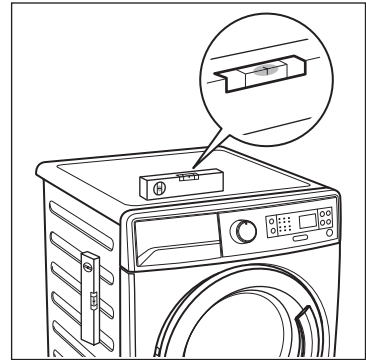

If you do not have a spirit level, as a guide use the edge of a door frame, cupboard or bench to check that the washing machine is leveled.

Loosen or tighten the feet to adjust the level. A correct adjustment of the appliance level prevents vibration, noise and the movement of the appliance when in operation.

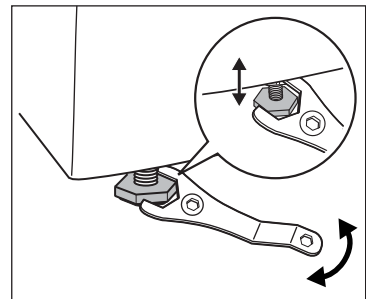

When the washing machine is levelled, try to rock it from corner to corner. If it does rock, adjust the legs again until it is levelled and does not rock.

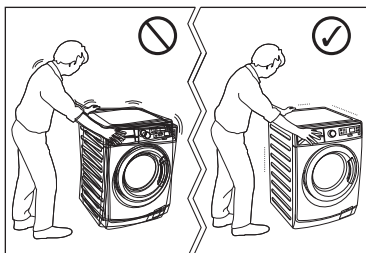

Never place cardboard, wood or similar materials under the machine to compensate for any unevenness in the floor. Install the machine on a flat hard floor. Make sure that air circulation around the machine is not impeded by carpets, rugs etc.

Check that the machine does not touch the wall or cupboard units.

### 11.3 Water Inlet

Connect the water inlet hose to a tap with 3/4" BSP thread.

Use the hose supplied with the washing machine. **DO NOT USE OLD HOSES.**

The other end of the inlet hose which connects to the machine can be turned in any direction.

Simply loosen the fitting, rotate the hose and retighten the fitting, making sure there are no water leaks.

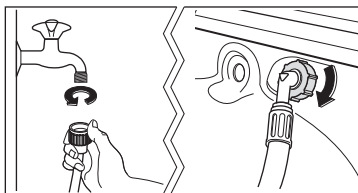

The inlet hose must not be lengthened. If it is too short and you do not wish to move the tap, you will have to purchase a new, longer hose specially designed for this type of use.

### 11.4 Water Drainage

The end of the drain hose can be positioned in three ways:

- Hooked over the edge of a sink using the plastic hose guide supplied with the machine.

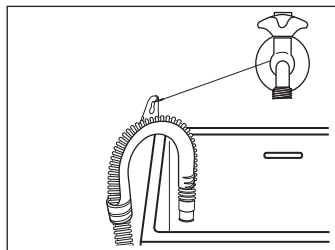

In this case, make sure the end cannot come unhooked when the machine is emptying.

This could be done by tying it to the tap with a piece of string or attaching it to the wall.

- In a sink drain pipe branch. This branch must be above the trap so that the bend is at least 60 cm above the ground.
- Directly into a drain pipe at a height of not less than 60 cm and not more than 90 cm.

The end of the drain hose must always be ventilated, i.e. the inside diameter of the drain pipe must be larger than the outside diameter of the drain hose.

The drain hose must not be kinked. Run it along the floor; only the part near the drainage point must be raised.

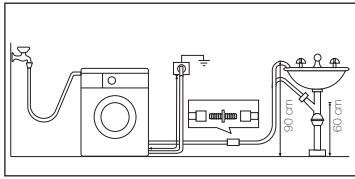

For the correct functioning of the machine the drain hose must remain hooked on the proper support piece situated on the top part of back side of the appliance.

## 11.5 Electrical Connection

This machine is designed to operate on a 220-240 V, single-phase, 50 Hz supply.

**“An incorrect power supply may void your warranty.”**

Check that your domestic electrical installation can take the maximum load required (2.1 kW), also taking into account any other appliances in use.



### **CAUTION!**

**Connect the machine to an earthed socket outlet.**

The manufacturer declines any responsibility for damage or injury through failure to comply with the above safety precaution.

Should the appliance power supply cable need to be replaced, this shall be carried out by our Service Centre.

When the appliance is installed the power supply cable must be easily accessible.

If this appliance is supplied from a cord extension set or electrical portable outlet device, the cord extension set or electrical portable device must be positioned so that it is not subject to splashing or ingress of moisture.

---



## 12. ENVIRONMENT CONCERNS

### 12.1 Packaging Materials



The materials marked with the symbol  are recyclable.

>PE<=polyethylene

>PS<=polystyrene

>PP<=polypropylene

This means that they can be recycled by disposing of them properly in appropriate collection containers.

### 12.2 Old Machine

Use authorised disposal sites for your old appliance. Help to keep your country tidy!

The symbol  on the product or on its packaging indicates that this product may not be treated as household waste.

Instead it shall be handed over to the applicable collection point for the recycling of electrical and electronic equipment.

By ensuring this product is disposed of correctly, you will help prevent potential negative consequences for the environment and human health, which could otherwise be caused by inappropriate waste handling of this product.

For more detailed information about recycling of this product, please contact your local city office, your household waste disposal service or the shop where you purchased the product.

### 12.3 Ecological Hints

To save water, energy and to help protect the environment, we recommend that you follow these tips:

- Normally soiled laundry may be washed without prewashing in order to save detergent, water and time (the environment is protected too!).
- The machine works more economically if it is fully loaded.
- With adequate pre-treatment, stains and limited soiling can be removed; the laundry can then be washed at a lower temperature.
- Measure out detergent according to the water hardness, the degree of soiling and the quantity of laundry being washed.

## NOTE



FOR SALES IN AUSTRALIA AND NEW ZEALAND  
 APPLIANCE: WASHING MACHINE, WASHER/DRYER

**This document sets out the terms and conditions of the product warranties for Electrolux Appliances. It is an important document. Please keep it with your proof of purchase documents in a safe place for future reference should you require service for your Appliance.**

1. In this warranty
  - (a) 'acceptable quality' as referred to in clause 10 of this warranty has the same meaning referred to in the ACL;
  - (b) 'ACL' means Schedule 2 to the Competition and Consumer Act 2010;
  - (c) 'Appliance' means any Electrolux product purchased by you and accompanied by this document;
  - (d) 'ASC' means Electrolux' authorised serviced centres;
  - (e) 'Electrolux' means Electrolux Home Products Pty Ltd of 163 O'Riordan Street, Mascot NSW 2020, ABN 51 004 762 341 in respect of Appliances purchased in Australia and Electrolux (NZ) Limited of 3-5 Niall Burgess Road, Mount Wellington, in respect of Appliances purchased in New Zealand;
  - (f) 'major failure' as referred to in clause 10 of this warranty has the same meaning referred to in the ACL and includes a situation when an Appliance cannot be repaired or it is un-economic for Electrolux, at its discretion, to repair an Appliance during the Warranty Period;
  - (g) 'Warranty Period' means the Appliance is warranted against manufacturing defects in Australia and New Zealand for 24 months with an additional 96 months parts only warranty for the Appliance's inverter motor , if applicable (for appliances purchased after 1st January 2015), following the date of original purchase of the Appliance;
  - (h) 'you' means the purchaser of the Appliance not having purchased the Appliance for re-sale, and 'your' has a corresponding meaning.
2. This warranty only applies to Appliances, purchased and used in Australia or New Zealand and is in addition to (and does not exclude, restrict, or modify in any way) any non-excludable statutory warranties in Australia or New Zealand and are used in normal domestic applications.
3. During the Warranty Period Electrolux or its ASC will, at no extra charge if your Appliance is readily accessible for service, without special equipment and subject to these terms and conditions, repair or replace any parts which it considers to be defective. Electrolux or its ASC may use remanufactured parts to repair your Appliance. You agree that any replaced Appliances or parts become the property of Electrolux. This warranty does not apply to light globes, batteries, filters or similar perishable parts.
4. Parts and Appliances not supplied by Electrolux are not covered by this warranty.
5. To the extent permitted by law, you will bear the cost of transportation, travel and delivery of the Appliance to and from Electrolux or its ASC. If you reside outside of the service area, you will bear the cost of:
  - (a) travel of an authorised representative;
  - (b) transportation and delivery of the Appliance to and from Electrolux or its ASC,

In all instances, unless the Appliance is transported by Electrolux or an Electrolux authorised representative, the Appliance is transported at the owner's cost and risk while in transit to and from Electrolux or its ASC.
6. Proof of purchase is required before you can make a claim under this warranty.
7. You may not make a claim under this warranty unless the defect claimed is due to faulty or defective parts or workmanship. Electrolux is not liable in the following situations (which are not exhaustive):
  - (a) the Appliance is damaged by:
    - (i) accident
    - (ii) misuse or abuse, including failure to properly maintain or service
    - (iii) normal wear and tear
    - (iv) power surges, electrical storm damage or incorrect power supply
    - (v) incomplete or improper installation
    - (vi) incorrect, improper or inappropriate operation
    - (vii) insect or vermin infestation
    - (viii) failure to comply with any additional instructions supplied with the Appliance;
  - (b) the Appliance is modified without authority from Electrolux in writing;
  - (c) the Appliance's serial number or warranty seal has been removed or defaced;
  - (d) the Appliance was serviced or repaired by anyone other than Electrolux, an authorised repairer or ASC.
8. This warranty, the contract to which it relates and the relationship between you and Electrolux are governed by the law applicable where the Appliance was purchased. Where the Appliance was purchased in New Zealand for commercial purposes the Consumer Guarantee Act does not apply.
9. To the extent permitted by law and subject to your non-excludable statutory rights and warranties, Electrolux excludes all warranties and liabilities (other than as contained in this document) including liability for any loss or damage whether direct or indirect arising from your purchase, use or non use of the Appliance.
10. For Appliances and services provided by Electrolux in Australia, the Appliances come with a guarantee by Electrolux that cannot be excluded under the ACL. You are entitled to a replacement or refund for a major failure and for compensation for any other reasonably foreseeable loss or damage. You are also entitled to have the Appliance repaired or replaced if the Appliance fails to be of acceptable quality and the failure does not amount to a major failure. The benefits to you given by this warranty are in addition to your other rights and remedies under a law in relation to the Appliances or services to which the warranty relates.
11. At all times during the Warranty Period, Electrolux shall, at its discretion, determine whether repair, replacement or refund will apply if an Appliance has a valid warranty claim applicable to it.
12. For Appliances and services provided by Electrolux in New Zealand, the Appliances come with a guarantee by Electrolux pursuant to the provisions of the Consumer Guarantees Act, the Sale of Goods Act and the Fair Trading Act.
13. To enquire about claiming under this warranty, please follow these steps:
  - (a) carefully check the operating instructions, user manual and the terms of this warranty;
  - (b) have the model and serial number of the Appliance available;
  - (c) have the proof of purchase (eg an invoice) available;
  - (d) telephone the numbers shown below.
14. You accept that if you make a warranty claim, Electrolux and its ASC may exchange information in relation to you to enable Electrolux to meet its obligations under this warranty.

**Important Notice**

Before calling for service, please ensure that the steps listed in clause 13 above have been followed.

|   |   |   |
|---|---|---|
| <b>FOR SERVICE</b><br>or to find the address of your nearest state service centre in Australia<br><b>PLEASE CALL 13 13 49</b><br><small>For the cost of a local call (Australia only)</small> | <b>SERVICE AUSTRALIA</b><br>ELECTROLUX HOME PRODUCTS<br>electrolux.com.au | <b>FOR SPARE PARTS</b><br>or to find the address of your nearest state spare parts centre in Australia<br><b>PLEASE CALL 13 13 50</b><br><small>For the cost of a local call (Australia only)</small> |
| <b>FOR SERVICE</b><br>or to find the address of your nearest authorised service centre in New Zealand<br><b>FREE CALL 0800 10 66 10</b><br><small>(New Zealand only)</small>                  | <b>SERVICE NEW ZEALAND</b><br>ELECTROLUX (NZ) Limited<br>electrolux.co.nz | <b>FOR SPARE PARTS</b><br>or to find the address of your nearest state spare parts centre in New Zealand<br><b>FREE CALL 0800 10 66 20</b><br><small>(New Zealand only)</small>                       |

www.electrolux.com



G001 1702-002-A00973024

