



Thinking of you
Electrolux



EVE678

.....
EN STEAM OVEN

.....
USER MANUAL



CONTENTS

1. SAFETY INFORMATION	3
2. SAFETY INSTRUCTIONS	4
3. PRODUCT DESCRIPTION	6
4. BEFORE FIRST USE	7
5. CONTROL PANEL	7
6. DAILY USE	9
7. CLOCK FUNCTIONS	13
8. AUTOMATIC PROGRAMMES	14
9. USING THE ACCESSORIES	14
10. ADDITIONAL FUNCTIONS	15
11. HELPFUL HINTS AND TIPS	17
12. CARE AND CLEANING	31
13. WHAT TO DO IF...	33
14. INSTALLATION	34
15. WARRANTY	38

WE'RE THINKING OF YOU

Thank you for purchasing an Electrolux appliance. You've chosen a product that brings with it decades of professional experience and innovation. Ingenious and stylish, it has been designed with you in mind. So whenever you use it, you can be safe in the knowledge that you'll get great results every time.

Welcome to Electrolux.

Visit our website for:



Get usage advice, brochures, trouble shooter, service information:
www.electrolux.com



Register your product for better service:
www.electrolux.com/productregistration



Buy Accessories, Consumables and Original spare parts for your appliance:
www.electrolux.com/shop

CUSTOMER CARE AND SERVICE

We recommend the use of original spare parts.

When contacting Service, ensure that you have the following data available.

The information can be found on the rating plate. Model, PNC, Serial Number.



Warning / Caution-Safety information



General information and tips



Environmental information

Subject to change without notice.

1. SAFETY INFORMATION

Before the installation and use of the appliance, carefully read the supplied instructions. The manufacturer is not responsible if an incorrect installation and use causes injuries and damages. Always keep the instructions with the appliance for future reference.

1.1 Children and vulnerable people safety



WARNING!

Risk of suffocation, injury or permanent disability.

- This appliance can be used by children aged from 8 years and above and persons with reduced physical, sensory or mental capabilities or lack of experience and knowledge if they are supervised by an adult or a person who is responsible for their safety.
- Do not let children play with the appliance.
- Keep all packaging away from children.
- Keep children and pets away from the appliance when it operates or when it cools down. Accessible parts are hot.
- If the appliance has a child safety device, we recommend that you activate it.
- Cleaning and user maintenance shall not be made by children without supervision.

1.2 General Safety

- Internally the appliance becomes hot when in operation. Do not touch the heating elements that are in the appliance. Always use oven gloves to remove or put in accessories or ovenware.
- Do not use a steam cleaner to clean the appliance.
- Before maintenance cut the power supply.

- Do not use harsh abrasive cleaners or sharp metal scrapers to clean the glass door since they can scratch the surface, which may result in shattering of the glass.
- To remove the shelf supports first pull the front of the shelf support and then the rear end away from the side walls. Install the shelf supports in the opposite sequence.

2. SAFETY INSTRUCTIONS

2.1 Installation



WARNING!

Only a qualified person must install this appliance.

- Remove all the packaging.
- Do not install or use a damaged appliance.
- Obey the installation instruction supplied with the appliance.
- Always be careful when you move the appliance because it is heavy. Always wear safety gloves.
- Do not pull the appliance by the handle.
- Keep the minimum distance from the other appliances and units.
- Make sure that the appliance is installed below and adjacent safe structures.
- The sides of the appliance must stay adjacent to appliances or to units with the same height.

Electrical connection



WARNING!

Risk of fire and electrical shock.

- All electrical connections should be made by a qualified electrician.
- The appliance must be earthed.
- Make sure that the electrical information on the rating plate agrees with the power supply. If not, contact an electrician.
- Always use a correctly installed shock-proof socket.

- Do not use multi-plug adapters and extension cables.
- Make sure not to cause damage to the mains plug and to the mains cable. Contact the Service or an electrician to change a damaged mains cable.
- Do not let mains cables to come in touch with the appliance door, specially when the door is hot.
- The shock protection of live and insulated parts must be fastened in such a way that it cannot be removed without tools.
- Connect the mains plug to the mains socket only at the end of the installation. Make sure that there is access to the mains plug after the installation.
- If the mains socket is loose, do not connect the mains plug.
- Do not pull the mains cable to disconnect the appliance. Always pull the mains plug.
- Use only correct isolation devices: line protecting cut-outs, fuses (screw type fuses removed from the holder), earth leakage trips and contactors.
- The electrical installation must have an isolation device which lets you disconnect the appliance from the mains at all poles. The isolation device must have a contact opening width of minimum 3 mm.

2.2 Use



WARNING!

Risk of injury, burns or electric shock or explosion.

- Use this appliance in a household environment.
- Do not change the specification of this appliance.
- Make sure that the ventilation openings are not blocked.
- Do not let the appliance stay unattended during operation.
- Deactivate the appliance after each use.
- Be careful, when you open the appliance door while the appliance is in operation. Hot air can release.
- Do not operate the appliance with wet hands or when it has contact with water.
- Do not apply pressure on the open door.
- Do not use the appliance as a work surface or as a storage surface.
- Always keep the appliance door closed when the appliance is in operation.
- Open the appliance door carefully. The use of ingredients with alcohol can cause a mixture of alcohol and air.
- Do not let sparks or open flames to come in contact with the appliance when you open the door.
- Do not put flammable products or items that are wet with flammable products in, near or on the appliance.

**WARNING!**

Risk of damage to the appliance.

- To prevent damage or discoloration to the enamel:
 - do not put ovenware or other objects in the appliance directly on the bottom.
 - do not put aluminium foil directly on the bottom of the appliance.
 - do not put water directly into the hot appliance.
 - do not keep moist dishes and food in the appliance after you finish the cooking.
 - be careful when you remove or install the accessories.
- Discoloration of the enamel has no effect on the performance of the appliance. It is not a defect in the sense of the warranty law.

- Use a deep pan for moist cakes. Fruit juices cause stains that can be permanent.

Steam Cooking

**WARNING!**

Risk of burns and damage to the appliance.

- Do not open the appliance door during steam cooking. Steam can release.

2.3 Care and Cleaning

**WARNING!**

Risk of injury, fire or damage to the appliance.

- Before maintenance, deactivate the appliance and disconnect the mains plug from the mains socket.
- Make sure the appliance is cold. There is the risk that the glass panels can break.
- Replace immediately the door glass panels when they are damaged. Contact the Service.
- Be careful when you remove the door from the appliance. The door is heavy!
- Clean regularly the appliance to prevent the deterioration of the surface material.
- Remaining fat or food in the appliance can cause fire.
- Clean the appliance with a moist soft cloth. Only use neutral detergents. Do not use abrasive products, abrasive cleaning pads, solvents or metal objects.
- If you use an oven spray, obey the safety instructions on the packaging.
- Do not clean the catalytic enamel (if applicable) with any kind of detergent.

2.4 Internal light

- The type of light bulb or halogen lamp used for this appliance, is only for household appliances. Do not use it for house lighting.

**WARNING!**

Risk of electrical shock.

- Before replacing the lamp, disconnect the appliance from the power supply.

- Only use lamps with the same specifications.

2.5 Disposal



WARNING!

Risk of injury or suffocation.

- Disconnect the appliance from the mains supply.
- Cut off the mains cable and discard it.
- Remove the door catch to prevent children and pets to get closed in the appliance.

3. PRODUCT DESCRIPTION

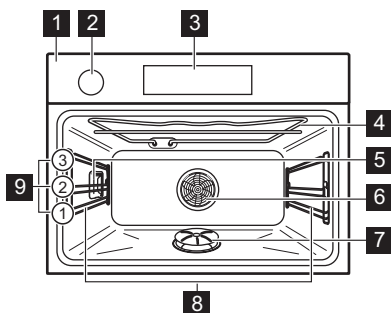

- 1** Control panel
- 2** Water drawer
- 3** Electronic programmer
- 4** Grill and heating element
- 5** Lamp
- 6** Fan and heating element
- 7** Steam generator with cover
- 8** Shelf support, removable
- 9** Shelf positions

3.1 Accessories



CAUTION!

Do not use the baking tray or deep pan with the Full Steam function.

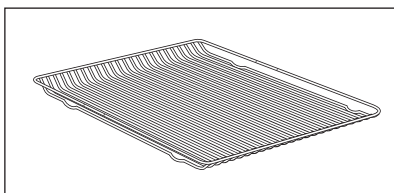

Wire shelf

For cookware, cake tins and roasts.

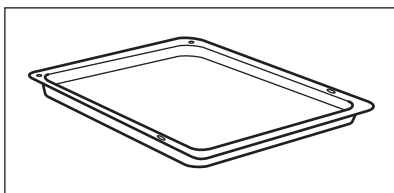

Baking tray

For cakes and biscuits.

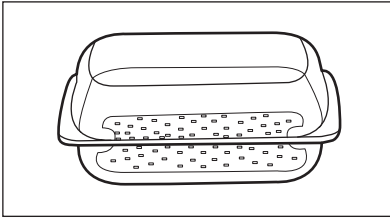

Glass dish with 2 grill inserts

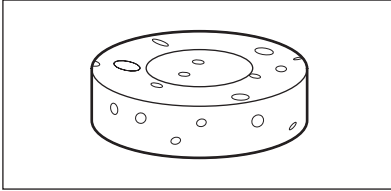
**Sponge**

For absorbing the remaining water from the steam generator.

4. BEFORE FIRST USE

**WARNING!**

Refer to the Safety chapters.

4.1 Initial Cleaning

- Remove all parts from the appliance.
- Clean the appliance before first use.



Refer to chapter "Care and Cleaning".

4.2 First Connection







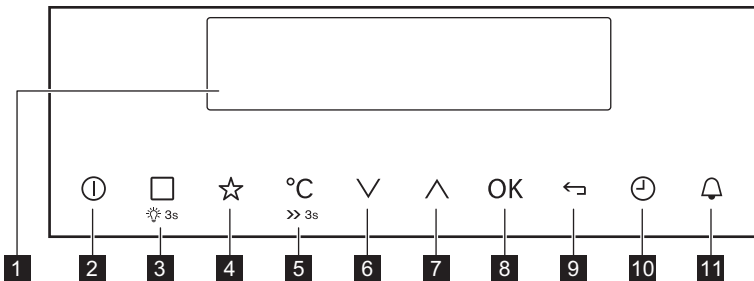

When you connect the appliance to the mains or after a power cut, you have to set the language, display contrast, display brightness and time of the day. Press **^** or **∨** to set the value. Press **OK** to confirm.

5. CONTROL PANEL

Electronic programmer



Use the sensor fields to operate the appliance





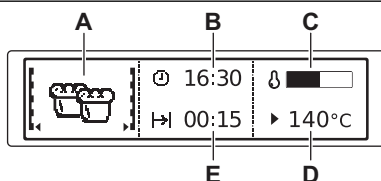



Number	Sensor field	Function	Comment
1	-	Display	It shows the settings of the appliance.
2		ON / OFF	To activate and deactivate the appliance.
3		Heating Functions or Assisted Cooking	To set a heating function or an Assisted Cooking function. To set the necessary function, touch the sensor field one or two times after you activate the appliance. To activate or deactivate the lamp, touch and hold the sensor field for 3 seconds (you can also activate the lamp after you deactivate the appliance).
4		Favourite Programme	To save your favourite programmes to use for a different time.
5		Temperature selection	To set the temperature or show the temperature in the appliance. To activate or deactivate the Fast Heat Up function, touch and hold the sensor field for 3 seconds.
6		Down key	To move down in the menu.
7		Up key	To move up in the menu.
8	OK	OK	To confirm the selection or settings.
9		Home key	To go back one level in the menu. To show the main menu, touch the field for 3 seconds.
10		Time and additional functions	To set different functions. When a heating function operates, touch the sensor field to set the timer, Function Lock, Favourite Programme memory, Heat + Hold or Set + Go.
11		Minute Minder	To set the Minute Minder.

5.1 Display



- A)** Heating function
- B)** Time of day
- C)** Heat up indicator
- D)** Temperature
- E)** Duration and End Time functions

Other indicators in the display

Symbol		Function
	Minute Minder	The function operates.
	Time of day	The display shows the time of day.
	Duration	The display shows the necessary time for cooking.
	End Time	The display shows when the cooking time is completed.
	Time indication	The display shows how long a heating function operates. Press ∇ and \blacktriangle at the same time to have the time go back to zero.
	Heat up indicator	The display shows the temperature in the appliance.
	Fast Heat Up Indicator	The function operates. This function decreases the heat up time.
	Weight Automatic	The display shows that the automatic weight system operates or that you can change the weight.
	Heat + Hold	The function operates.

6. DAILY USE



WARNING!

Refer to the Safety chapters.

6.1 Navigating the menus

Operation of the menus:





1. Activate the appliance.



2. Press ∇ or \blacktriangle to select the menu option.
3. Press **OK** to move to submenu or accept setting.

At every point you can get back to the main menu with \leftarrow .















6.2 The menus in overview

Main menu

Symbol	Menu item	Application
	Heating Functions	Contains a list of heating functions.
	Assisted Cooking	Contains a list of automatic cooking programmes.
	Favourite Programme	Contains a list of favourite cooking programmes stored by the user.
	Steam Cleaning	Contains the procedure for cleaning with steam.

Symbol	Menu item	Application
	Basic Settings	Contains a list of other settings.
	Specials	Contains a list of additional heating functions.









Submenus for: **Basic Settings**

Symbol	Submenu	Description
	Set Time of Day	Sets the current time on the clock.
	Time Indication	When ON, the display shows the current time after you deactivate the appliance.
	SET + GO	When ON, you can select the SET + GO function in the Select Options window.
	Heat + Hold	When ON, you can select the Heat + Hold function in the Select Options window.
	Extra time	Activates and deactivates the Extra time function.
	Display Contrast	Adjusts the display contrast by degrees.
	Display Brightness	Adjusts the display brightness by degrees.
	Set Language	Sets the language for the display.
	Buzzer Volume	Adjusts the volume of press-tones and signals by degrees.
	Key Tones	Activates and deactivates the tone of the touch fields. It is not possible to deactivate the tone of the ON / OFF touch field.
	Alarm/Error Tones	Activates and deactivates the alarm tones.
	Cleaning Assistant	Helps you with the cleaning procedure.
	Service	Shows the software version and configuration.
	Factory Settings	Resets all settings to factory settings.







6.3 Heating functions

Submenu for: **Heating functions**

Heating function	Application
 True Fan Cooking	To bake on up to 2 oven levels at the same time and to dry food. Set the oven temperatures 20 - 40 °C lower than when using Conventional Cooking .

Heating function	Application
 Moist Fan Baking	For energy-saving baking and cooking of mainly dry bakery items as well as for baking in tins on one shelf position.
 Slow Cook	To prepare tender, succulent roasts.
 Grilling	To grill flat food and to toast bread.
 Turbo Grilling	To roast larger joints of meat or poultry on one shelf position. Also to gratinate and to brown.
 Steam Regenerating	To reheat already cooked food directly on a plate.
 Quarter Steam + Heat	To bake bread, roast large pieces of meat or to warm up chilled and frozen meals.
 Half Steam + Heat	To steam dishes with a high moisture content and to poach fish, custard royale and terrine.
 Full Steam	To steam vegetables, fish, potatoes, rice, pasta or special side-dishes.

Submenu for: **Specials**

Heating function	Application
 Bread Baking	To bake bread.
 Au Gratin	For dishes such as lasagna or potato gratin. Also to gratinate and to brown.
 Dough Proving	For controlled rising of yeast dough before baking.
 Plate Warming	To preheat your plate for serving.
 Preserving	To preserve vegetables in glasses and liquid (e.g. mixed pickles).
 Keep Warm	To keep food warm.
 Defrost	To defrost frozen food.

6.4 Activating a heating function

1. Activate the appliance.
2. Select the Heating Functions menu. Press **OK** to confirm.
3. Set the heating function. Press **OK** to confirm.
4. Set the temperature. Press **OK** to confirm.



Press once or twice  to go directly to the Heating Functions menu (when the appliance is activated).

6.5 Steam cooking



The water drawer cover is in the control panel.

1. Press the cover to open the water drawer.
2. Fill the water drawer with 700 ml of water.

The water supply is sufficient for approximately 30 minutes.





CAUTION!

Do not put water directly into the steam generator!



Use only water as the liquid. Do not use filtered (demineralised) or distilled water.

3. Activate the appliance.
4. Set the steam heating function and temperature.
5. If necessary, set the function Duration  or End Time .

The first steam shows after approximately 2 minutes. An acoustic signal sounds when the appliance is at approximately the set temperature.

The signal sounds again at the end of the cooking time.

6. Deactivate the appliance.



When the steam generator is empty, an acoustic signal sounds. When the appliance is cool, soak up all remaining water from the steam generator with the sponge. If necessary, clean the steam generator with some vinegar. Let the appliance dry fully with the door open.

6.6 Heat-up indicator

When you activate a heating function, the bar on the display comes on. The bar shows that the temperature increases.

Fast Heat Up Indicator

This function decreases the heat-up time. To activate the function, hold  for 3 seconds. You will see the heat-up indicator alternates.

Residual heat

When you deactivate the appliance, the display shows the residual heat. You can use the heat to keep the food warm.

6.7 Energy saving



The appliance contains features which help you save energy during everyday cooking:







• Residual heat:

- When the heating function or programme operates, the heating elements are deactivated 10% earlier (the lamp and fan continue to operate). For this feature to operate, the cooking time must be longer than 30 minutes or you must use the clock functions (Duration , End Time).
- When the appliance is off, you can use the heat to keep food warm. The display shows the remaining temperature.

- **Cooking with the lamp off** - Touch and hold  for 3 seconds to deactivate the lamp during cooking.

7. CLOCK FUNCTIONS

7.1 Clock functions



Symbol	Function	Description
	Minute Minder	To set a countdown (maximum: 2 hours, 30 minutes). This function has no effect on the operation of the appliance. You can also activate it when the appliance is deactivated. Touch  to activate the function. Touch  or  to set the minutes and OK to start.
	Duration	To set the length of an operation (maximum: 23 hours, 59 minutes).
	End Time	To set the switch-off time for a heating function (maximum: 23 hours, 59 minutes).

If you set the time for a clock function, the time starts to count down after 5 seconds.



If you use the clock functions Duration and End Time, the appliance deactivates the heating elements after 90% of the set time. The appliance uses the residual heat to continue the cooking procedure until the time ends (3 – 20 minutes).

Setting the clock functions:

1. Set a heating function.
2. Touch  again and again until the display shows the necessary clock function and the related symbol.
3. Touch  or  to set the necessary time. Touch **OK** to confirm.

When the time ends, an acoustic signal sounds. The appliance deactivates. The display shows a message.

4. Touch a sensor field to stop the signal.
- With Duration and End Time, the appliance deactivates automatically.
 - With Duration and End Time, you must set the heating function and the temperature first. Then you can set the clock function.
 - You can use Duration and End Time at the same time if you want to automatically activate and deactivate the appliance at a given time later.

7.2 Heat + Hold

The Heat + Hold function keeps prepared food warm at 80 °C for 30 minutes. It activates after the baking or roasting procedure ends.

- You can activate or deactivate the function in the Basic Settings menu.
- Conditions for the function:
 - The set temperature is more than 80 °C.
 - The function Duration is set.

Activating the function

1. Activate the appliance.
2. Select the heating function.
3. Set the temperature above 80 °C.
4. Press  again and again until the display shows Heat + Hold. Press **OK** to confirm.

When the function ends, an acoustic signal sounds.

The Heat + Hold function stays on if you change the heating functions.



7.3 Extra Time

The Extra Time makes the heating function continue after the Duration ends.

- Applicable for all heating functions with Duration or Weight Automatic.

Activating the function:

1. When the cooking time ends, an acoustic signal sounds. Press any sensor field.

2. The display shows the message for Extra Time for one minute.
3. Press  to activate (or  to cancel).

4. Set the Extra Time period. Press **OK** to confirm.

8. AUTOMATIC PROGRAMMES



WARNING!

Refer to the Safety chapters.

8.1 Assisted Cooking with Recipe Automatic

This appliance has a set of recipes you can use. Recipes are fixed and you cannot change them.

Activating the function:

1. Activate the appliance.
2. Select the Assisted Cooking menu. Press **OK** to confirm.
3. Select the category and dish. Press **OK** to confirm.
4. Select Recipe Automatic . Press **OK** to confirm.







When you use the Manual function, the appliance uses automatic settings. You can change them as with other functions.

8.2 Assisted Cooking with Weight Automatic

This function automatically calculates the roasting time. To use it, it is necessary to input the food weight.

Activating the function:

1. Activate the appliance.
2. Select Assisted Cooking . Press **OK** to confirm.
3. Select the category and dish. Press **OK** to confirm.
4. Select the Weight Automatic . Press **OK** to confirm.
5. Touch  or  to set the food weight. Press **OK** to confirm.

The automatic programme starts. You can change the weight at any time. Press  or  to change the weight. When the time ends, an acoustic signal sounds. Press a sensor field to deactivate the signal.



With some programmes turn over the food after 30 minutes. The display shows a reminder.

9. USING THE ACCESSORIES



WARNING!

Refer to the Safety chapters.

9.1 Inserting the accessories

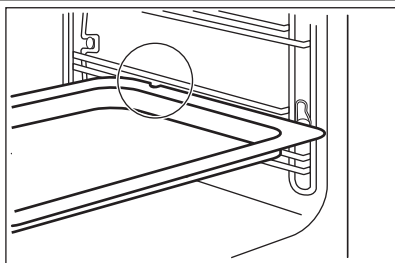

Baking tray:

Push the baking tray between the guide bars of the shelf support.

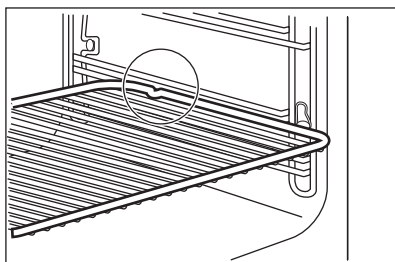

Wire shelf:

Push the shelf between the guide bars of the shelf support and make sure that the feet point down.

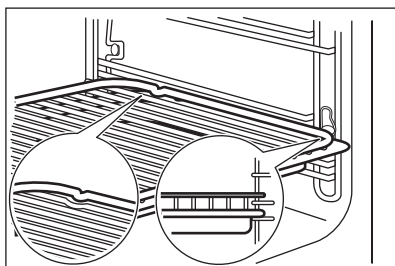

Wire shelf and baking tray together:

Push the baking tray between the guide bars of the shelf support and the wire shelf on the guide bars above.

- All accessories have small indentations at the bottom of the right and left edges to increase safety. Always make sure that these indentations are at the rear of the appliance. The indentations are also anti-tip devices.
- The high rim around the shelf is a device which prevents cookware from slipping.

10. ADDITIONAL FUNCTIONS

10.1 Favourite Programme menu

You can save your favourite settings, like duration, temperature or heating function. They are available in the Favourite Programme menu. You can save 20 programmes.

Saving a programme

1. Activate the appliance.
2. Set a heating function or an Assisted Cooking function.
3. Touch  again and again until the display shows **SAVE**. Press **OK** to confirm.

4. The display shows the first free memory position.
Press **OK** to confirm.
 5. Enter the name of the programme. The first letter flashes.
Touch ∇ or \blacktriangle to change the letter.
Press **OK**.
 6. Touch ∇ or \blacktriangle to move the cursor to the right or to the left. Press **OK**.
The next letter flashes. Do steps 5 and 6 again as necessary.
 7. Press and hold **OK** to save.
- You can overwrite a memory position. When the display shows the first free memory position, touch ∇ or \blacktriangle and press **OK** to overwrite an existing programme.
 - To change the name of a programme, select the Edit Programme Name sub-menu in the Favourite Programme menu.

Activating the programme

1. Activate the appliance.
2. Select the Favourite Programme menu. Press **OK** to confirm.
3. Select your favourite programme name. Press **OK** to confirm.

Press \star to go to Favourite Programme directly. You can also use it when the appliance is deactivated (for selected models only).

10.2 Function Lock

The Function Lock function prevents an accidental change of the heating function. You can activate the Function Lock function only when the appliance operates.

Activating the Function Lock function:

1. Activate the appliance.
2. Set a heating function or setting.
3. Press \odot again and again until the display shows Function Lock function.
4. Press **OK** to confirm.

Deactivating the Function Lock function:

1. Press \odot two times.

2. Press **OK** to confirm.

10.3 Child Lock

The Child Lock prevents an accidental operation of the appliance.

Activating and deactivating the Child Lock function:

1. Activate the appliance.
2. Touch \odot and \star at the same time until the display shows a message.

10.4 SET + GO

The SET + GO function lets you set a heating function (or programme) and use it later with one press of the sensor field.

Activating the function:

1. Activate the appliance.
2. Set the heating function.
3. Press \odot again and again until the display shows Duration .
4. Set the time.
5. Press \odot again and again until the display shows SET + GO .
6. Press **OK** to confirm.

To start SET + GO function, press any sensor field (except for \odot). The set heating function starts.

When the heating function ends, an acoustic signal sounds.

- When the heating function operates, the Function Lock function is on.
- You can activate and deactivate the SET + GO function in the Basic Settings menu.

10.5 Automatic switch-off

For safety reasons the appliance deactivates after some time:

- If a heating function operates.
- If you do not change the oven temperature.

Oven temperature	Switch-off time
30 °C - 115 °C	12.5 h
120 °C - 195 °C	8.5 h
200 °C - 230 °C	5.5 h



The automatic switch-off works with all functions, except Light , Duration and End Time .

surfaces of the appliance cool. If you deactivate the appliance, the cooling fan can continue to operate until the appliance cools down.

10.6 Cooling fan

When the appliance operates, the cooling fan activates automatically to keep the

11. HELPFUL HINTS AND TIPS

11.1 Inner side of door

In some models on the inner side of the door you can find:

- the numbers of the shelf positions (selected models)
- information about the heating functions, recommended shelf positions and temperatures for typical dishes (selected models).



The temperature and baking times in the tables are guidelines only. They depend on the recipes, quality and quantity of the ingredients used.

11.2 Advice for special heating functions of the appliance

Keep Warm

Use this function if you want to keep food warm.

The temperature regulates itself automatically to 80 °C.

Plate Warming

For warming plates and dishes. Distribute plates and dishes evenly on the oven shelf. Move stacks around after half of the warming time (swap top and bottom).

The automatic temperature is 70 °C. Recommended shelf position: 3.

Dough Proving

You can use this automatic function with any recipe for yeast dough you like. It gives you a good atmosphere for rising. Put the dough into a dish that is big enough for rising and cover it with a wet towel or plastic foil. Insert a wire shelf on level one and put the dish in. Close the door and set the function dough proving. Set the necessary time.

11.3 Steam cooking tables



WARNING!

Do not open the appliance door when the function is active. Risk of burns.

The function is suitable for all types of food — fresh and frozen. You can use it for cooking, warming, defrosting, poaching, or blanching vegetables, meat, fish, pasta, rice, sweet corn, semolina and eggs.

Cooking of menus: You can prepare complete set in one go. To avoid under or over cooked dishes choose those which require similar cooking times. Use the largest amount of water specified for individual component. Put the dishes on the oven shelves in the suitable cookware. Adjust the gap between the dishes to let the steam circulate.

Sterilisation

- With the Full Steam function you can sterilise containers (e.g. baby bottles).
- Put the clean containers in the middle of the shelf on the 1st level. Make sure

that the opening faces down at a small angle.

- Fill the water drawer with the maximum amount of water and set a time of 40 minutes.

Full Steam table

Food	Water amount (ml)	Temperature (°C)	Shelf position	Time 1) (min)
Risotto	400	96	2	25 - 30
Rice (water / rice ratio 1,5 : 1)	650	96	2	35 - 40
Cornmeal (polenta, with liquid 1 : 3)	550	96	2	35 - 40
Jacket potatoes, medium-sized	650	96	2	50 - 60
Boiled potatoes	550	96	2	35 - 40
Ratatouille	400	96	2	25 - 30
Brussels sprouts	550	96	2	30 - 35
Broccoli in florets	550	96	2	25 - 30
Cauliflower, whole	650	96	2	40 - 45
Cauliflower in florets	600	96	2	20 - 25
Sauerkraut	650	96	2	50 - 60
Tomatoes, whole	250	96	2	15 - 20
Beetroot, whole	650 + 400	96	2	60 - 70
Kohlrabi / celery / fennel, sliced	550	96	2	35 - 40
Courgettes, sliced	400	96	2	20 - 25
Carrots, sliced	550	96	2	35 - 40
Defrosting vegetables	550	96	2	35
Defrosting and cooking vegetables	650	60	2	35 - 40
Blanching vegetables	250	96	2	12 - 15
Blanching beans	250	96	2	20 - 22
Frozen beans	650	96	2	30 - 40
Chicken (breast)	500	96	2	30 - 40
Prosciutto style ham (1000 g)	650	96	2	50 - 75
Smoked loin of pork (600 - 1000 g)	650	96	2	45 - 55

Food	Water amount (ml)	Temperature (°C)	Shelf position	Time ¹⁾ (min)
Stuffed pepper	500	96	2	30 - 40
Frankfurters / veal sausages	250	85	2	15 - 20
Heating up meat loaf in 1 cm slices	400	96	2	20 - 25
Fish fillet (approx. 1000 g)	650	96	2	35 - 40
Flat fish fillet (approx. 300 g)	300	80	2	15 - 20
Fish fillet, frozen (500 - 800 g)	650	96	2	30 - 40
Trout (170 - 300 g)	400	85	2	15 - 25
Custard / flan in individual dishes	500	96	2	25 - 35
Egg royale	500	96	2	25 - 35
Steamed buns	500	96	2	30 - 35
Eggs, soft	200	96	2	9 - 12
Eggs, medium	200	96	2	13 - 15
Eggs, hard	200	96	2	16 - 20

¹⁾ The times are for guidance only.

Half Steam + Heat Cooking table

Food	Half Steam + Heat (water amount about 300 ml)		
	Temperature (°C)	Time ¹⁾ (min)	Shelf position
Custard / flan in individual dishes ²⁾	90	40 - 45	1
Baked eggs ²⁾	90	35 - 45	1
Terrine ²⁾	90	40 - 50	1
Thin fish fillet	85	15 - 25	1
Thick fish fillet	90	25 - 35	1
Small fish up to 350 g	90	25 - 35	1
Whole fish up to 1000 g	90	35 - 45	1
Reheating			
Dumplings	110	20 - 30	1

Food	Half Steam + Heat (water amount about 300 ml)		
	Temperature (°C)	Time ¹⁾ (min)	Shelf position
Pasta	110	15 - 20	1
Rice	110	15 - 20	1
One-plate dishes	110	15 - 20	1

1) The times are for guidance only.

2) Continue for a further half an hour with the door closed.

Quarter Steam + Heat table

Cooking on more than one oven level			
Food	Quarter Steam Cooking (Max. amount of water 250 ml)		
	Temperature (°C)	Time (min)	Shelf position
Heating up a meal, 6 plates, 24 cm in diameter	110	15 - 20	2 and 4
Roast pork (1000 g)	180	90 - 100	2
Roast beef (1000 g)	180	90 - 100	2
Roast veal (1000 g)	180	80 - 90	2
Meat loaf, raw (500 g)	180	30 - 40	2
Frankfurters / veal sausages	85	15 - 20	2
Smoked loin of pork, pre-soak for 2 hours (600 - 1000 g)	185	60 - 70	2
Chicken (1000 g)	200	45 - 55	2
Duck (1500 - 2000 g)	180	60 - 75	2
Goose (3000 g)	170	130 - 170	1
Fish fillets	90	20 - 30	2
Potato gratin, Leek and potato gratin	190	40 - 50	2
Pasta bake	180	35 - 45	2
Lasagne	180	45 - 50	2
Misc. types of bread (500 - 1000 g)	180 - 190	50 - 60	2
Rolls (40 - 60 g)	210 - 220	20 - 25	3
Ready-to-bake rolls (30 - 40 g)	220	10 - 15	3
Ready-to-bake rolls, frozen (30 - 40 g)	220	10 - 15	3

Cooking on more than one oven level			
Food	Quarter Steam Cooking (Max. amount of water 250 ml)		
	Temperature (°C)	Time (min)	Shelf position
Ready-to-bake baguettes (40 - 50 g)	200	10 - 15	3
Ready-to-bake baguettes, frozen (40 - 50 g)	200	10 - 15	3

Slice the roasts before you heat them up. The data in the table is for guidance only. The data depends on the size and amount of food.

11.4 Baking

General instructions

- Your new appliance may bake or roast differently to the appliance you had before. Adapt your usual settings (temperature, cooking times) and shelf positions to the values in the tables.
- With longer baking times, the appliance can be switched off about 10 minutes before the end of baking time, to use the residual heat.

When you use frozen food, the trays in the appliance can twist during baking. When the trays get cold again, the distortion will be gone.

How to use the Baking Tables

- We recommend to use the lower temperature the first time.
- If you cannot find the settings for a special recipe, look for the one that is almost the same.
- Baking time can be extended by 10 - 15 minutes, if you bake cakes on more than one level.
- Cakes and pastries at different heights do not always brown equally at first. If this occurs, do not change the temperature setting. The differences equalize during the baking procedure.
- Unless otherwise stated, the values in the tables assume that the appliance is cold when the cooking starts.

11.5 Tips on baking

Baking results	Possible cause	Remedy
The bottom of the cake is not browned sufficiently.	The shelf position is incorrect.	Put the cake on a lower shelf.
The cake sinks and becomes soggy, lumpy or streaky.	The oven temperature is too high.	The next time you bake, set a slightly lower oven temperature.
The cake sinks and becomes soggy, lumpy or streaky.	The baking time is too short.	Set a longer baking time. You cannot decrease baking times by setting higher temperatures.
The cake sinks and becomes soggy, lumpy or streaky.	There is too much liquid in the mixture.	Use less liquid. Be careful with mixing times, especially if you use a mixing machine.

Baking results	Possible cause	Remedy
The cake is too dry.	The oven temperature is too low.	The next time you bake, set a higher oven temperature.
The cake is too dry.	The baking time is too long.	The next time you bake, set a shorter baking time.
The cake browns unevenly.	The oven temperature is too high and the baking time is too short.	Set a lower oven temperature and a longer baking time.
The cake browns unevenly.	The mixture is unevenly distributed.	Spread the mixture evenly on the baking tray.
The cake is not ready in the baking time given.	The oven temperature is too low.	The next time you bake, set a slightly higher oven temperature.

11.6 Baking on one oven level

Heating function: True Fan Cooking 

Baking in tins

Food	Shelf position	Temperature (°C)	Time (min)
Ring cake or brioche	1	160 - 170	50 - 60
Madeira cake / Fruit cakes	1	150 - 170	70 - 90
Fatless sponge cake / Fatless sponge cake	1	160 - 180	25 - 40
Flan base - shortcrust pastry	2	170 - 190 ¹⁾	10 - 25
Flan base - sponge mixture	2	150 - 170	20 - 25
Apple tart (covered)	1	160 - 180	50 - 60
Apple pie / Apple pie (2 tins, Ø 20cm, placed diagonally)	1	180 - 190	65 - 80
Savoury flan (e. g. Quiche Lorraine)	2	170 - 190	30 - 70
Cheesecake	1	160 - 180	60 - 90

¹⁾ Preheat oven.

Cakes / pastries / breads on baking trays

Food	Shelf position	Temperature (°C)	Time (min)
Plaited bread / bread crown	1	160 - 180	30 - 40
Christmas stollen	1	160 - 180	40 - 60
Bread (rye bread)	1	180 - 200	45 - 60

Food	Shelf position	Temperature (°C)	Time (min)
Cream puffs / éclairs	2	170 - 190	30 - 40
Swiss Roll	2	200 - 220 1)	8 - 15
Crumb cake (dry)	2	160 - 180	20 - 40
Butter / sugar cake	2	180 - 200 1)	15 - 30
Fruit flan (made with yeast dough / sponge mixture)	2	160 - 180	25 - 50
Fruit flan made with short-crust pastry	2	170 - 190	40 - 80
Yeast cakes with delicate toppings (e. g. quark, cream, almond slice)	2	150 - 170	40 - 80
Pizza (with a lot of topping)	2	190 - 210 1)	20 - 40
Pizza (thin crust)	2	230 1)	12 - 20
Flat bread	2	230 1)	10 - 20
Swiss flaky pastry tarts	2	190 - 210	35 - 50

1) Preheat oven.

Biscuits

Food	Shelf position	Temperature (°C)	Time (min)
Short pastry biscuits	2	160 - 180	6 - 20
Viennese whirls	2	160	10 - 40
Biscuits made with sponge mixture	2	160 - 180	15 - 20
Pastries made with egg white, meringues	2	80 - 100	120 - 150
Macaroons	2	100 - 120	30 - 60
Fancy yeast biscuits	2	160 - 180	20 - 40
Puff pastries	2	180 - 200 1)	20 - 30
Rolls	2	210 - 230	20 - 35
Small cakes / Small cakes (20 per tray)	2	170 1)	20 - 30

1) Preheat the oven.

Baking on more than one level - Biscuits / small cakes / pastries / rolls

Food	True Fan Cooking 2 shelf positions	Temperature (°C)	Time (min)
Short pastry biscuits	2 / 3	160 - 180	15 - 35
Viennese whirls	2 / 3	160	20 - 60

Food	True Fan Cooking 2 shelf positions	Temperature (°C)	Time (min)
Biscuits made with sponge mixture	2 / 3	160 - 180	25 - 40
Pastries made with egg white, meringues	2 / 3	80 - 100	130 - 170
Macaroons	2 / 3	100 - 120	40 - 80
Danish pastries	2 / 3	160 - 180	30 - 60
Puff pastries	2 / 3	180 - 200 ¹⁾	30 - 50

¹⁾ Preheat oven.

11.7 Soufflés and au gratin dishes table

Heating function: True Fan Cooking 

Food	Shelf position	Temperature (°C)	Time (min)
Pasta bake	1	180 - 200	30 - 50
Lasagne	1	180 - 200	25 - 40
Vegetables au gratin ¹⁾	1	160 - 170	15 - 30
Baguettes au gratin ¹⁾	1	160 - 170	15 - 30
Sweet bakes	1	180 - 200	40 - 60
Fish bakes	1	180 - 200	30 - 60
Stuffed vegetables	1	160 - 170	30 - 60
Potato gratin	2	180 - 200	40 - 50

¹⁾ Preheat oven.

Ready made frozen food table

Food	Heating Function	Shelf position	Temperature (°C)	Time (min)
Frozen pizza	True Fan Cooking	3	as per manufacturer's instructions	as per manufacturer's instructions
Chips ¹⁾ (300 - 600 g)	Turbo Grilling	3	200 - 220	as per manufacturer's instructions
Baguettes	True Fan Cooking	3	as per manufacturer's instructions	as per manufacturer's instructions
Fruit cake	True Fan Cooking	3	as per manufacturer's instructions	as per manufacturer's instructions

¹⁾ Turn chips 2 or 3 times during cooking

11.8 Roasting

Roasting dishes

- Use heat-resistant ovenware to roast (refer to the instructions of the manufacturer).
- You can roast large roasting joints directly in the deep pan (if present) or on the wire shelf above the deep pan.
- Roast lean meats in the roasting tin with the lid. This keeps the meat more succulent.
- All types of meat that can be browned or have crackling can be roasted in the roasting tin without the lid.
- We recommend that you cook meat and fish weighing 1 kg and above in the appliance.

- To prevent the meat juices or fat from burning onto the pan, put some liquid into the deep pan.
- If necessary, turn the roast (after 1 / 2 - 2 / 3 of the cooking time).
- Baste large roasts and poultry with their juices several times during roasting. This gives better roasting results.
- You can deactivate the appliance approximately 10 minutes before the end of the roasting time, and use the residual heat.

11.9 Roasting tables

Heating function: True Fan Cooking 

Pork

Food	Weight (g)	Shelf position	Temperature (°C)	Time (min)
Shoulder, neck, ham joint	1000 - 1500	1	170 - 190	90 - 120
Chops, smoked loin of pork	1000 - 1500	1	180 - 200	60 - 90
Meat loaf	750 - 1000	1	180 - 200	45 - 60
Knuckle of pork (pre-cooked)	750 - 1000	1	170 - 190	90 - 120

Beef

Food	Weight (g)	Shelf position	Temperature (°C)	Time (min)
Pot roast	1000 - 1500	1	180 - 200	120 - 150
Roast beef or sirloin	per cm of thickness	1	210 - 230 ¹⁾	6 - 9 per cm of thickness

¹⁾ Preheat the oven.

Veal

Food	Weight (g)	Shelf position	Temperature (°C)	Time (min)
Pot roast	1000 - 1500	1	170 - 190	150 - 120
Knuckle of veal	1500 - 2000	1	170 - 190	120 - 150

Lamb

Food	Weight (g)	Shelf position	Temperature (°C)	Time (min)
Leg of lamb	1000 - 1500	1	170 - 190	75 - 120
Saddle of lamb	1000 - 1500	1	180 - 200	60 - 90

Quick roast items cooked on a baking tray

Food	Shelf position	Temperature (°C)	Time (min)
Sausages 'Cordon bleu'	1	220 - 230 1)	5 - 8
Small sausages	1	220 - 230 1)	12 - 15
Schnitzel or chops, breaded	1	220 - 230 1)	15 - 20
Rissoles	1	210 - 220 1)	15 - 20

Fish (steamed)

Food	Weight (g)	Shelf position	Temperature (°C)	Time (min)
Whole fish	1000 - 1500	1	210 - 220	45 - 75

Poultry

Food	Weight (g)	Shelf position	Temperature (°C)	Time (min)
Chicken, spring chicken	1000 - 1500	1	190 - 210	45 - 75
Chicken half	per 400 - 500	1	200 - 220	35 - 50
Poultry pieces	per 200 - 250	1	200 - 220	35 - 50
Duck	1500 - 2000	1	180 - 200	75 - 105

Game

Food	Weight (g)	Shelf position	Temperature (°C)	Time (min)
Saddle of hare, leg of hare	up to 1000	1	220 - 230 1)	25 - 40
Saddle of venison	1500 - 2000	1	210 - 220	75 - 105
Leg of venison	1500 - 2000	1	200 - 210	90 - 135

11.10 Slow Cook

- Slow Cook function is correct for pieces of tender, lean meat and fish to make them succulent.
- Do not use Slow Cook function for pot roasts or fatty pork roasts.
- Always cook without a lid in Slow Cook function.
- With Slow Cook function the oven gets the preset temperature and a signal operates. Then, the oven automatically sets to a lower temperature to continue cooking.

Cooking with Slow Cook function:

1. Sear the meat in a pan in a very high heat.
2. Put the meat in a roasting dish or directly on the wire shelf.
3. Put the tray below the shelf to catch the fat.

4. Put the shelf in the oven.

5. Set Slow Cook function.

If it is necessary, change the temperature and cook until done (refer to Slow Cook table).

Beef

Food to be cooked	Weight (g)	Searing each side (min)	Temperature (°C)	Shelf position	Time (min)
Filet medium	1000 - 1500	2	80 - 90	1	90 - 110
Roast beef medium	1000 - 1500	4	80 - 90	1	180 - 240

Veal

Food to be cooked	Weight (g)	Searing each side (min)	Temperature (°C)	Shelf position	Time (min)
Filet rosé	1000 - 1500	2	80 - 90	1	90 - 120
Loin, in one piece	1000 - 1500	4	80 - 90	1	120 - 150
Nierstück	1000 - 1500	4	80 - 90	1	120 - 150

Pork

Food to be cooked	Weight (g)	Searing each side (min)	Temperature (°C)	Shelf position	Time (min)
Filet rosé	1000 - 1500	2	80 - 90	1	90 - 110
Loin, in one piece	1000 - 1500	4	80 - 90	1	150 - 170
Nierstück	1000 - 1500	4	80 - 90	1	150 - 170

11.11 Grilling

Grilling setting with maximum temperature



Grill with the oven door closed.

- Use both the wire shelf and the tray when you grill.
- The grilling time is for guidance only.

Grilling table

Food	Shelf position	Cooking times (min)	
		1st side	2nd side
Rissoles	3	8 - 10	6 - 8
Pork fillet	2	10 - 12	6 - 10
Sausages	3	8 - 10	6 - 8
Fillet steaks, veal steaks	3	6 - 7	5 - 6
Fillet of beef, roast beef (approx. 1 kg)	2	10 - 12	10 - 12
Toast / Toast ¹⁾	3	4 - 6	3 - 5
Toast with topping	2	8 - 10	---

¹⁾ Use the wire shelf without a tray

11.12 Turbo Grilling

Heating function: Turbo Grilling

Food	Temperature (°C)	Shelf position		Time (min)	turn after (min)
		Deep pan	Wire shelf		
Chicken (900 - 1000 g)	180 - 200	1	2	50 - 60	25 - 30
Stuffed rolled pork roast (2000 g)	180 - 200	1	2	90 - 95	45
Pasta bake	180	---	2	30	---
Potato bake au gratin	200	---	2	20 - 23	---
Gnocchi, au gratin	180	---	2	20 - 23	---
Cauliflower with Hollandaise sauce	200	---	2	15	---

11.13 Defrosting

Heating function: Defrost  (Temperature setting 30 °C)

- Unpack the food and put it on a plate on the first shelf position from the bottom.
- Do not cover with anything to decrease the defrosting time.

Defrosting table

Food	Time (min)	Further defrosting time (min)	Note
Chicken, 1000 g	100 - 140	20 - 30	Put the chicken on an upturned saucer in a big plate. Turn halfway through
Meat, 1000 g	100 - 140	20 - 30	Turn halfway through

Food	Time (min)	Further defrosting time (min)	Note
Meat, 500 g	90 - 120	20 - 30	Turn halfway through
Trout, 150 g	25 - 35	10 - 15	---
Strawberries, 300 g	30 - 40	10 - 20	---
Butter, 250 g	30 - 40	10 - 15	---
Cream, 2 x 200 g	80 - 100	10 - 15	Whip the cream when still slightly frozen in places
Gateau, 1400 g	60	60	---

11.14 Drying

Heating function: Drying 

- Cover trays with grease proof paper or baking parchment.

- For a better result, stop the appliance halfway through the drying time, open the door and let it cool down for one night to complete the drying.

Drying table

Food	Temperature (°C)	Shelf position		Time (h)
		1 position	2 positions	
Beans	75	2	2 / 3	6 - 9
Pepper slices	75	2	2 / 3	5 - 8
Vegetables for soup	75	2	2 / 3	5 - 6
Mushrooms	50	2	2 / 3	6 - 9
Herbs	40 - 50	2	2 / 3	2 - 4
Plums	75	2	2 / 3	8 - 12
Apricots	75	2	2 / 3	8 - 12
Apple slices	75	2	2 / 3	6 - 9
Pears	75	2	2 / 3	9 - 13

11.15 Making preserves

Heating function: Preserving 

- Use only preserve jars of the same dimensions available on the market.
- Do not use jars with twist - off and bayonet type lids, or metal tins. The results can be worse the expectations.
- Use the first shelf from the bottom for this function.
- Put no more than six one - litre preserve jars on the baking tray.
- Fill the jars up to the same level and close with a clamp.
- The jars cannot touch each other.
- Put approximately 1 / 2 litre of water into the baking tray to give sufficient moisture in the appliance.
- When the liquid in the jars starts to simmer (after approx. 35 - 60 minutes with one - litre jars), stop the appliance or decrease the temperature to 100 °C (see the table).

Preserves table - Berries

Preserve	Temperature (°C)	Cooking time until simmering (min)	Cooking time at 100 °C (min)
Strawberries, blueberries, raspberries, ripe gooseberries	160 - 170	35 - 45	---
Unripe gooseberries	160 - 170	35 - 45	10 - 15

Preserves table - Stone fruits

Preserve	Temperature (°C)	Cooking time until simmering (min)	Cooking time at 100 °C (min)
Pears, quinces, plums	160 - 170	35 - 45	10 - 15

Preserves table - Vegetables

Preserve	Temperature (°C)	Cooking time until simmering (min)	Cooking time at 100 °C (min)
Carrots ¹⁾	160 - 170	50 - 60	5 - 10
Cucumbers	160 - 170	50 - 60	---
Mixed pickles	160 - 170	50 - 60	15
Kohlrabi, peas, asparagus	160 - 170	50 - 60	15 - 20

¹⁾ Keep in the oven after you stop the oven

11.16 Bread Baking

Add 100 ml of water to the water drawer.

Preheating is not recommended.

Type of baking	Oven function	Shelf position	Temperature (°C)	Time (min)
White Bread	Bread baking	2	180 - 200	40 - 60
Baguette	Bread baking	2	200 - 220	35 - 45
Brioche	Bread baking	2	180 - 200	40 - 60
Ciabatta	Bread baking	2	200 - 220	35 - 45
Rye Bread	Bread baking	2	190 - 210	50 - 70
Dark Bread	Bread baking	2	180 - 200	50 - 70
All Grain bread	Bread baking	2	170 - 190	60 - 90

12. CARE AND CLEANING



WARNING!

Refer to the Safety chapters.

Notes on cleaning:

- Clean the front of the appliance with a soft cloth with warm water and a cleaning agent.
- To clean metal surfaces, use a usual cleaning agent.
- Clean the oven interior after each use. Then you can remove dirt more easily and it does not burn on.
- Clean all oven accessories after each use and let them dry.
- If you have nonstick accessories, do not clean them using aggressive agents, sharp-edged objects or a dishwasher. It can cause a damage to the nonstick coating.

12.1 Steam Cleaning

1. Remove the worst of the dirt manually.

12.2 Shelf supports

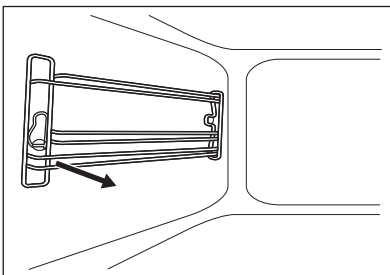
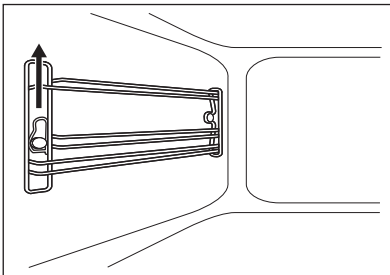

You can remove the shelf supports to clean the side walls.

Removing the shelf supports

1. Pull the support up and out of the front catch carefully.
2. Pull the front end of the shelf support away from the side wall.

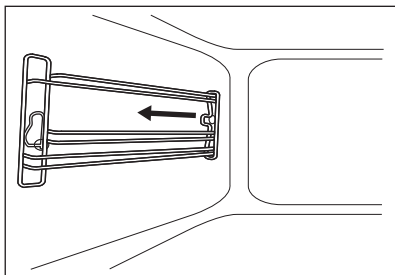

Installing the shelf supports

To install the shelf support follow the procedure in the opposite order.

12.3 Steam generation system



CAUTION!

Dry the steam generator **after each use**. Soak up water with the sponge.



Remove the limescale residue with water and vinegar.



CAUTION!

Chemical de-scaling agents can cause damage to the enamel. Follow the instructions of the manufacturer.

Cleaning the water drawer and the steam generator:

1. Put the water and vinegar mixture (approximately 250 ml) **through the water drawer** into the steam generator.

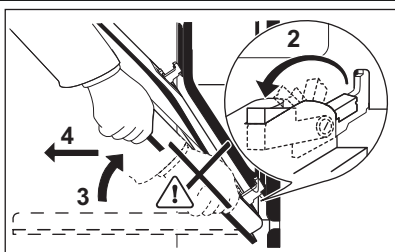

3. Pull the support out of the rear catch.

Wait for approximately 10 minutes.

2. Remove the water and vinegar with the sponge.
3. Put clean water (100 - 200 ml) into the water drawer to flush the steam generation system.
4. Remove water from the steam generator with the sponge and rub dry.
5. Keep the door open to let the appliance dry fully.

12.4 Removing / inserting the door

Remove the door to clean the inner side of the appliance.



WARNING!

Pull the door away from the appliance. The door is heavy!



CAUTION!

Put the door with the outer side down on a soft and level surface to prevent scratches.

Removing the door

1. Open the door as far as it goes.
2. Lift up the clamping levers on both door hinges fully.
3. Hold the door on both sides with both hands and close it approximately 3 / 4 of the way going through the point of resistance.

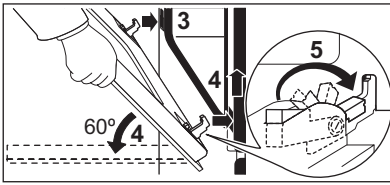

Inserting the door

1. Hold the door on both sides at an angle of approximately 60° (from the side of the door with the handle).
2. Push the door hinges at the same time into the two recesses at the bottom of the appliance on the left and the right as far as they go.
3. Shut the door only to a point of resistance and then open it as far as it goes.
4. Lock the clamping levers on the hinges fully.
5. Close the door.

12.5 Lamp



WARNING!

Danger of electrocution! Disconnect the fuse before you replace the lamp.
The lamp and the lamp glass cover can be hot.

Before you change the lamp:

- Deactivate the appliance.
- Remove the fuses from the fuse box or deactivate the circuit breaker.



CAUTION!

Put a cloth on the bottom of the interior of the appliance. It prevents damage to the lamp glass cover and the cavity.
Always use the same lamp type.

Replacing the side lamp:

1. Remove the left shelf support.
2. Use a Torx 20 screwdriver to remove the cover.
3. Remove and clean the metal frame and the seal.
4. Replace the lamp with a halogen, 230 V, 25 W, 300 °C heat resistant oven lamp.
5. Install the metal frame and the seal. Tighten the screws.
6. Install the left shelf support.



13. WHAT TO DO IF...



WARNING!

Refer to the Safety chapters.

Problem	Possible cause	Remedy
The appliance does not heat up.	The appliance is deactivated.	Activate the appliance.
The appliance does not heat up.	The clock is not set.	Set the clock.
The appliance does not heat up.	The necessary settings are not set.	Make sure that the settings are correct.
The appliance does not heat up.	The Child Lock is activated.	Refer to "Activating and deactivating the Child Lock function".

Problem	Possible cause	Remedy
The appliance does not heat up.	The fuse is released.	Make sure that the fuse is the cause of the malfunction. If the fuse releases again and again, contact an authorized electrician.
The lamp does not operate.	The lamp is defective.	Replace the lamp.
"Demo" comes on in the display and the appliance does not heat up. The fan does not operate.	The test mode is activated.	<ol style="list-style-type: none"> 1. Deactivate the appliance. 2. Touch and hold  until the appliance activates and deactivates. 3. Touch and hold  and  at the same time until an acoustic signal sounds and "Demo" goes out.

If you cannot find a solution to the problem yourself, contact your dealer or the service centre.

The necessary data for the service centre is on the rating plate. The rating plate is on the front frame of the appliance cavity.

We recommend that you write the data here:

Model (Mod.)
 Product number (PNC)
 Serial number (Serie:)

14. INSTALLATION

 **WARNING!**
 Refer to the Safety chapters.

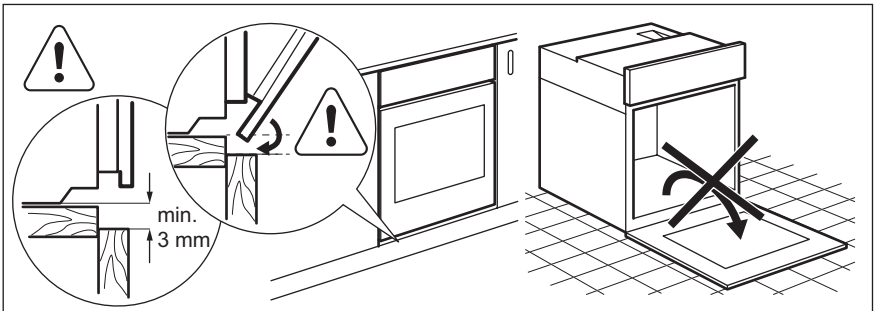

 To lift the appliance, do not use the door handle.

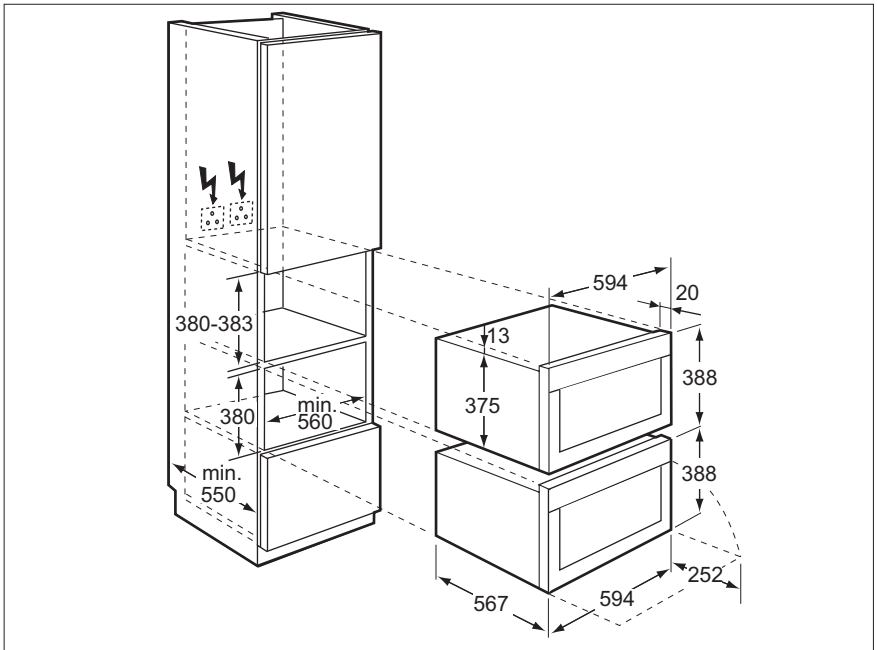
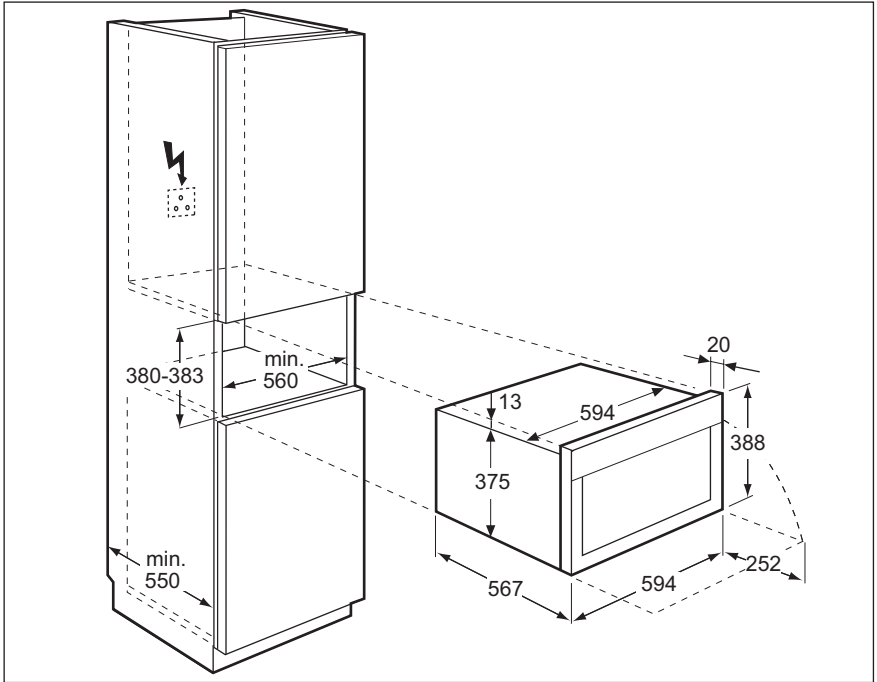

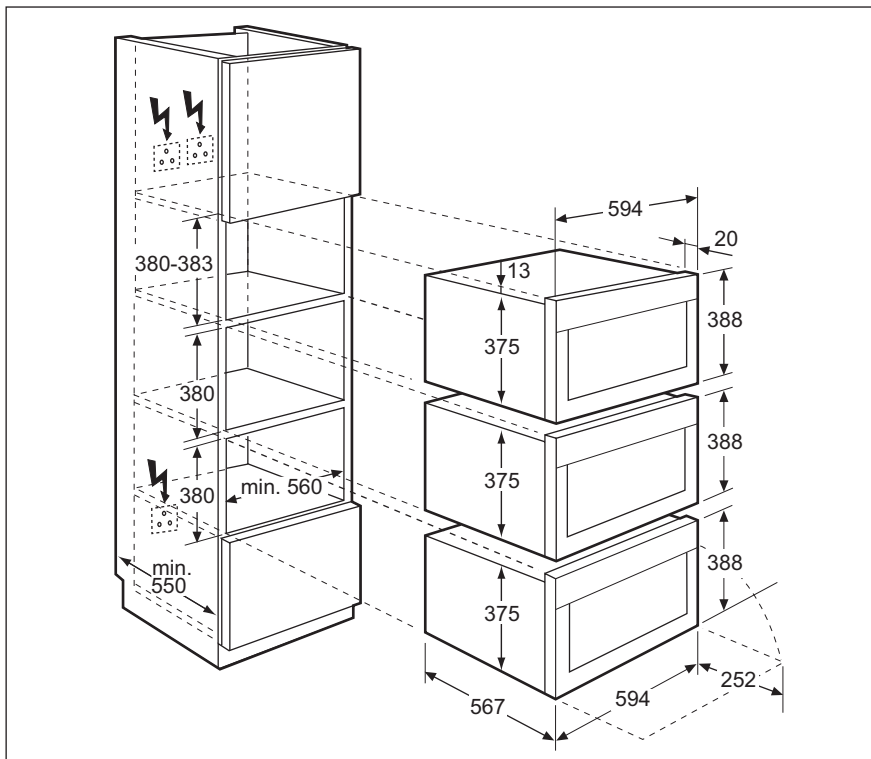

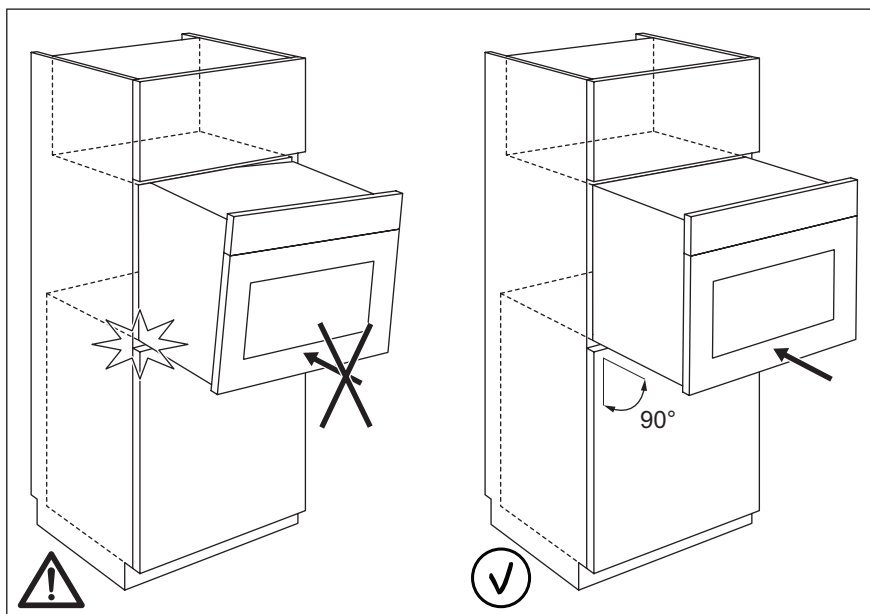
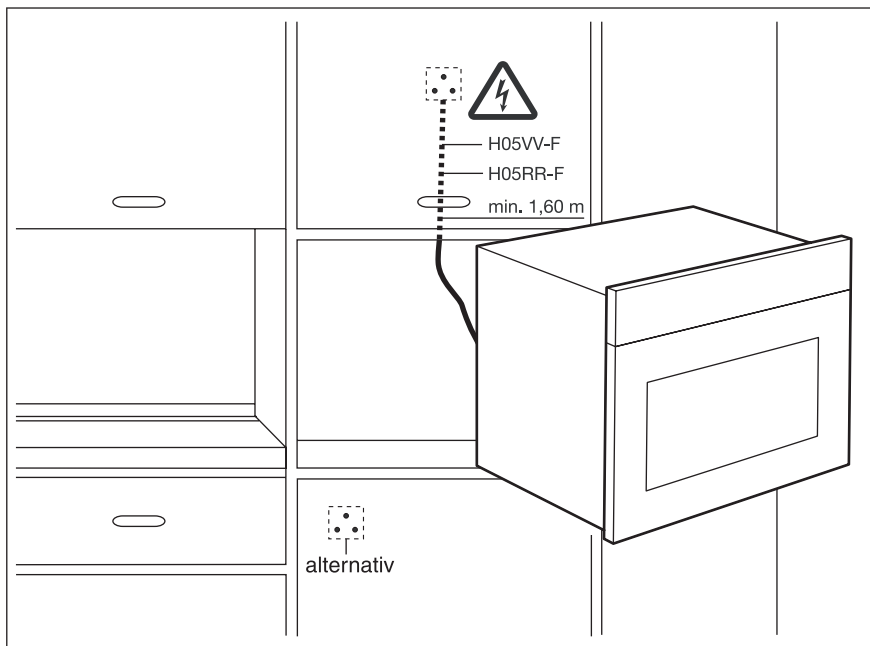

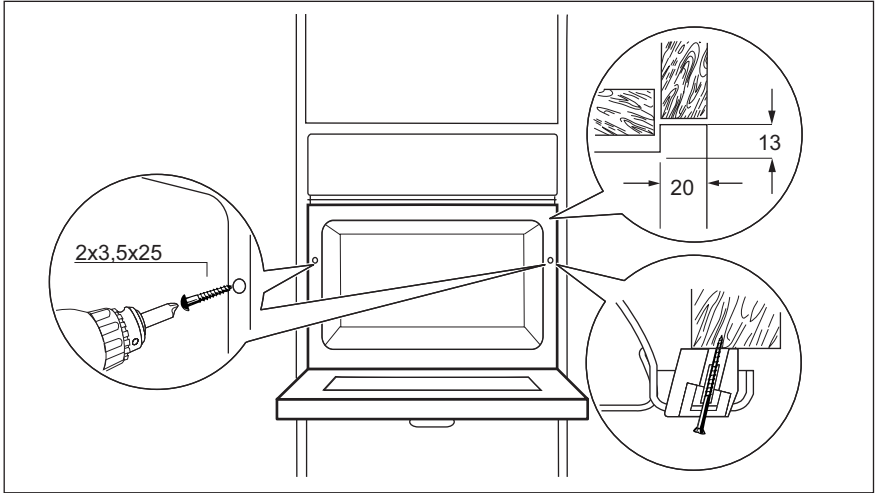

15. WARRANTY

Electrolux

FOR SALES IN AUSTRALIA AND NEW ZEALAND
 APPLIANCE: BUILT-IN OVEN, COOKTOP AND FREESTANDING COOKER

This document sets out the terms and conditions of the product warranties for Electrolux Appliances. It is an important document. Please keep it with your proof of purchase documents in a safe place for future reference should you require service for your Appliance.

1. In this warranty

- a) 'acceptable quality' as referred to in clause 10 of this warranty has the same meaning referred to in the ACL;
- b) 'ACL' means Trade Practices Amendment (Australian Consumer Law) Act (No.2) 2010;
- c) 'Appliance' means any Electrolux product purchased by you accompanied by this document;
- d) 'ASC' means Electrolux' authorised serviced centres;
- e) 'Electrolux' means Electrolux Home Products Pty Ltd of 163

O'Riordan Street, Mascot, NSW 2020, ABN 51 004 762 341 in respect of Appliances purchased in Australia and Electrolux (NZ) Limited of 3-5 Niall Burgess Road, Mount Wellington, in respect of Appliances purchased in New Zealand;

- f) 'major failure' as referred to in clause 10 of this warranty has the same meaning referred to in the ACL and includes a situation when an Appliance cannot be repaired or it is uneconomic for Electrolux, at its discretion, to repair an Appliance during the Warranty Period;
- g) 'Warranty Period' means:
 - where the Appliance is used for personal, domestic or household use (i.e. normal single family use) as set out in the instruction manual, the Appliance is warranted against manufacturing defects in Australia for 24 months and in New Zealand for 24 months, following the date of original purchase of the Appliance;

- where the Appliance is used for commercial purposes (including being used to directly assist a business or where the Appliance is used in a multi-family communal or share type environment), the Appliance will then be warranted against manufacturing defects in Australia for 3 months and in New Zealand for 3 months, following the date of original purchase of the Appliance.
- h)** ‘you’ means the purchaser of the Appliance not having purchased the Appliance for re-sale, and ‘your’ has a corresponding meaning.
- 2.** This warranty only applies to Appliances purchased and used in Australia or New Zealand and is in addition to (and does not exclude, restrict, or modify in any way) any non-excludable statutory warranties in Australia or New Zealand.
 - 3.** During the Warranty Period Electrolux or its ASC will, at no extra charge if your Appliance is readily accessible for service, without special equipment and subject to these terms and conditions, repair or replace any parts which it considers to be defective. Electrolux or its ASC may use remanufactured parts to repair your Appliance. You agree that any replaced Appliances or parts become the property of Electrolux. This warranty does not apply to light globes, batteries, filters or similar perishable parts.
 - 4.** Parts and Appliances not supplied by Electrolux are not covered by this warranty.
 - 5.** You will bear the cost of transportation, travel and delivery of the Appliance to and from Electrolux or its ASC. If you reside outside of the service area, you will bear the cost of:
 - a)** travel of an authorised representative;
 - b)** transportation and delivery of the Appliance to and from Electrolux or its ASC,

In all instances, unless the Appliance is transported by Electrolux or an Electrolux authorised representative, the Appliance is transported at the owner’s cost and risk while in transit to and from Electrolux or its ASC.
 - 6.** Proof of purchase is required before you can make a claim under this warranty.
 - 7.** You may not make a claim under this warranty unless the defect claimed is due to faulty or defective parts or workmanship. Electrolux is not liable in the following situations (which are not exhaustive):
 - a)** the Appliance is damaged by:
 - accident
 - misuse or abuse, including failure to properly maintain or service
 - normal wear and tear
 - power surges, electrical storm damage or incorrect power supply
 - incomplete or improper installation
 - incorrect, improper or inappropriate operation
 - insect or vermin infestation
 - failure to comply with any additional instructions supplied with the Appliance;
 - b)** the Appliance is modified without authority from Electrolux in writing;
 - c)** the Appliance’s serial number or warranty seal has been removed or defaced;
 - d)** the Appliance was serviced or repaired by anyone other than Electrolux, an authorised repairer or ASC.
 - 8.** This warranty, the contract to which it relates and the relationship between you and Electrolux are governed by the law applicable where the Appliance was purchased. Where the Appliance was purchased in New Zealand for business purposes the Consumer Guarantee Act does not apply.
 - 9.** To the extent permitted by law, Electrolux excludes all warranties and liabilities (other than as contained in this document) including liability for any loss or damage whether direct or indirect arising from your purchase, use or non use of the Appliance.

10. For Appliances and services provided by Electrolux in Australia, the Appliances come with a guarantee by Electrolux that cannot be excluded under the Australian Consumer Law. You are entitled to a replacement or refund for a major failure and for compensation for any other reasonably foreseeable loss or damage. You are also entitled to have the Appliance repaired or replaced if the Appliance fails to be of acceptable quality and the failure does not amount to a major failure. The benefits to you given by this warranty are in addition to your other rights and remedies under a law in relation to the Appliances or services to which the warranty relates.
11. At all times during the Warranty Period, Electrolux shall, at its discretion, determine whether repair, replacement or refund will apply if an Appliance has a valid warranty claim applicable to it.
12. For Appliances and services provided by Electrolux in New Zealand, the Appliances come with a guarantee by Electrolux pursuant to the provisions of the Consumer Guarantees Act, the Sale of Goods Act and the Fair Trading Act.
13. To enquire about claiming under this warranty, please follow these steps:
 - a) carefully check the operating instructions, user manual and the terms of this warranty;
 - b) have the model and serial number of the Appliance available;
 - c) have the proof of purchase (eg an invoice) available;
 - d) telephone the numbers shown below.
14. You accept that if you make a warranty claim, Electrolux and its ASC may exchange information in relation to you to enable Electrolux to meet its obligations under this warranty.

Important Notice

Before calling for service, please ensure that the steps listed in point 13 above have been followed.

<p>FOR SERVICE or to find the address of your nearest state service centre in Australia Please call 13 13 4 9 For the cost of a local call (Australia only)</p>	<p>SERVICE AUSTRALIA  Electrolux ELECTROLUX HOME PRODUCTS www.electrolux.com.au</p>	<p>FOR SPARE PARTS or to find the address of your nearest state spare parts centre in Australia Please call 13 13 50 For the cost of a local call (Australia only)</p>
<p>FOR SERVICE or to find the address of your nearest authorised service centre in New Zealand Free call 0800 10 66 10 (New Zealand only)</p>	<p>SERVICE NEW ZEALAND  Electrolux ELECTROLUX HOME PRODUCTS www.electrolux.co.nz</p>	<p>FOR SPARE PARTS or to find the address of your nearest state spare parts centre in New Zealand Free call 0800 10 66 20 (New Zealand only)</p>

16. ENVIRONMENT CONCERNS

Recycle the materials with the symbol . Put the packaging in applicable containers to recycle it. Help protect the environment and human health and to recycle waste of electrical

and electronic appliances. Do not dispose appliances marked with the symbol  with the household waste. Return the product to your local recycling facility or contact your municipal office.

www.electrolux.com/shop



892960002-A-042013

