



*Thinking of you*  
**Electrolux**



.....  
User manual

.....  
Side by side refrigerators

.....  
ESE6107  
ESE6977  
ESE7007  
ESE6077



## WE'RE THINKING OF YOU

Thank you for purchasing an Electrolux appliance. You've chosen a product that brings with it decades of professional experience and innovation. Ingenious and stylish, it has been designed with you in mind. So whenever you use it, you can be safe in the knowledge that you'll get great results every time.

Welcome to Electrolux.

## LEGEND

The symbols you will see in this booklet have these meanings:



### **WARNING!**

**This symbol indicates information concerning your personal safety**



### **CAUTION!**

**This symbol indicates information on how to avoid damaging the refrigerator**



### **IMPORTANT!**

**This symbol indicates tips and information about use of the refrigerator**



### **ENVIRONMENT!**

**This symbol indicates tips and information about economical and ecological use of the refrigerator**

## CONDITIONS OF USE

This appliance is intended to be used in household and similar applications such as:

- Staff kitchen areas in shops, offices and other working environments
- Farm houses
- By clients in hotels, motels and other residential type environments
- Bed and breakfast type environments.
- Catering and similar non-retail applications

## RECORD MODEL AND SERIAL NUMBER HERE:

Model: \_\_\_\_\_

Serial No: \_\_\_\_\_

## CONTENTS

3	<b>Important safety instructions</b>
4	<b>General Warnings</b>
5	<b>Components</b>
5	<b>ESE6107</b>
6	<b>ESE6977</b>
7	<b>ESE7007</b>
8	<b>ESE6077</b>
9	<b>General installation</b>
11	<b>Ice and water installation</b>
15	<b>Initial start up</b>
16	<b>Using your refrigerator – general</b>
17	<b>Food compartment features</b>
19	<b>Ice &amp; Water features</b>
20	<b>Electronic display panel - ESE6107, ESE7007</b>
22	<b>Electronic display panel - ESE6077, ESE6977</b>
25	<b>Ice and water dispenser</b>
27	<b>Changing the water filter</b>
27	<b>LED lighting</b>
28	<b>Cleaning your refrigerator</b>
29	<b>Helpful hints</b>
30	<b>Troubleshooting</b>
32	<b>Ice and water troubleshooting</b>
35	<b>Warranty</b>

## BEFORE USING YOUR APPLIANCE

Before you use the refrigerator, we recommend that you read through the relevant sections of this manual, which provides the description of your appliance and its functions.

To avoid the risks that are always present when you use an appliance, it is important that the appliance is installed correctly and that you read the safety instructions carefully to avoid misuse and hazards.

We recommend that you keep this instruction booklet for future reference and pass it on to any future owners.

After unpacking the appliance please check it is not damaged. If in doubt, do not use the appliance but contact your local customer care centre.

### **IMPORTANT!**

#### **Check for any damage or marks**

If you find the refrigerator is damaged or marked, you must report it within 7 days if you wish to claim for damage/marks under the manufacturer's warranty.

This does not affect your statutory rights.

### **ENVIRONMENT!**

- Most of the packing materials are recyclable. Please dispose of those materials marked with the recycle symbol  through your local recycling depot or by placing them in appropriate collection containers.
- If you wish to discard this product, please contact your local authorities and ask for the correct method of disposal.
- Local authorities will have the latest information regarding safe disposal of the product.
- Incorrect disposal may expose the user to injury from sharp objects, flammable gasses or cause environmental damage.
- Refrigerant gasses within the unit should only be discharged by qualified persons. A licence may be required by your local authorities to discharge or reclaim the refrigerant gasses. Incorrect discharge of gasses may expose the user to injury from flammable gasses or cause environmental damage.
- When you dispose of your old refrigerators or freezers remove any doors. Children can suffocate if they get trapped inside a discarded unit.

## IMPORTANT SAFETY INSTRUCTIONS

### **WARNING!**

- This appliance is not intended for use by persons (including children) with reduced physical, sensory or mental capabilities, or lack of experience or knowledge, unless they are being supervised or have been given instruction concerning use of the appliance by a person responsible for their safety. Children should be supervised to ensure that they do not play with the appliance.
- Don't use a steam cleaner. If live components come into contact with condensing steam, they may short circuit or cause an electric shock.
- Do not use mechanical devices or other means to accelerate the defrosting process other than those recommended by the manufacturer.
- This appliance contains insulation formed with flammable blowing gases. Avoid safety hazards by carefully disposing of this appliance.

#### **R600a refrigerant warning**

- This appliance may contain flammable R600a refrigerant. Avoid safety hazards by carefully installing, handling, servicing and disposing of this appliance. If your appliance contains R600a it will be indicated on the rating plate inside the appliance.
- Ensure that the tubing of the refrigerant circuit is not damaged during transportation and installation.
- In the event any damage accidentally occurs, keep the appliance away from open fires and any devices that produce sparks or arcs and luminaries during normal or abnormal operation, and unplug the appliance at the power point. Call authorised service for necessary action and advice.
- Leaking refrigerant may ignite vent area if leak occurs.
- The room for installing appliance must be at least 1m<sup>3</sup> per 8g of refrigerant. The amount and type of refrigerant in the appliance can be found on the rating plate inside the appliance.
- It is hazardous for anyone other than an authorised service person to service this appliance.
- In Queensland the authorised service person MUST hold a gas work authorisation for hydrocarbon refrigerants to carry out servicing or repairs which involve the removal of covers.

## GENERAL WARNINGS

Read the following carefully to avoid damage or injury

⊗ **This symbol indicates never to do this**

⊙ **This symbol indicates always do this**

It is important to use your refrigerator safely.

Check these safety points before using your refrigerator.

⊙ The appliance must be plugged into its own dedicated 220-240V, 50Hz AC electrical outlet.
⊙ Ensure that the electrical outlet is properly earthed. Consult a qualified electrician if you are unsure.
⊙ If the power cord is damaged, it must be replaced by the manufacturer, its service agent or similarly qualified persons in order to avoid a hazard.
⊙ Check that the power cord can reach the power point. Don't plug your refrigerator into an extension cord or double adaptor.
⊙ Unplug the appliance before cleaning.
⊙ Choose a location that is not too cold – the ambient temperature should be above 10°C.
⊙ Put the refrigerator in a dry place avoiding areas of high moisture or humidity.
⊙ Keep ventilation openings in the appliance enclosure or in the built-in structure clear of obstruction.
⊙ The plug to the appliance must be accessible when the unit is in the installed position.
⊗ Never unplug the appliance by pulling on the power cord. Always grip the plug firmly, and pull straight out of the receptacle to prevent damaging the power cord.
⊗ Don't plug your refrigerator into a timer fitted to the power point.
⊗ Do not put the refrigerator in frosty or unprotected areas, for example in a garage or on a veranda.
⊗ Do not put the refrigerator in direct sunlight, near stoves, fires or heaters.
⊗ Do not put the refrigerator on an uneven surface.
⊗ Do not store explosive substances such as aerosol cans with a flammable propellant in this appliance.
⊗ Do not use electrical appliances inside the food storage compartments of the appliance, unless they are of the type recommended by the manufacturer.
⊗ Never store fizzy drinks in the freezer compartment.
⊗ Never try to repair the refrigerator yourself, only use a qualified or authorised service person for repairs.
⊗ Never use electric heaters or dryers to defrost the freezer because you can receive an electric shock.
⊗ Do not damage the refrigerant circuit.

### For ice & water models only

⊙ Check for water leaks at all water connection points in the first two or three hours after installation. Re-check after 24 hours to ensure connection is watertight. If the connection is leaking, contact a licensed plumber.
⊗ Do not use with water that is microbiologically unsafe or with water of unknown quality without adequate disinfection.
⊗ Never connect the appliance to a hot water supply.
⊗ Never install the water filter in an area of the wall where there may be electrical wires and/or water supply pipes.
⊗ Never install the water filter in an area of direct sunlight.

*Note: You must read these warnings carefully before installing or using the refrigerator. If you need assistance, contact your Customer Care Department. The manufacturer will not accept liability, should these instructions or any other safety instructions incorporated in this book be ignored.*



## ESE6107 WITH STANDARD FEATURES

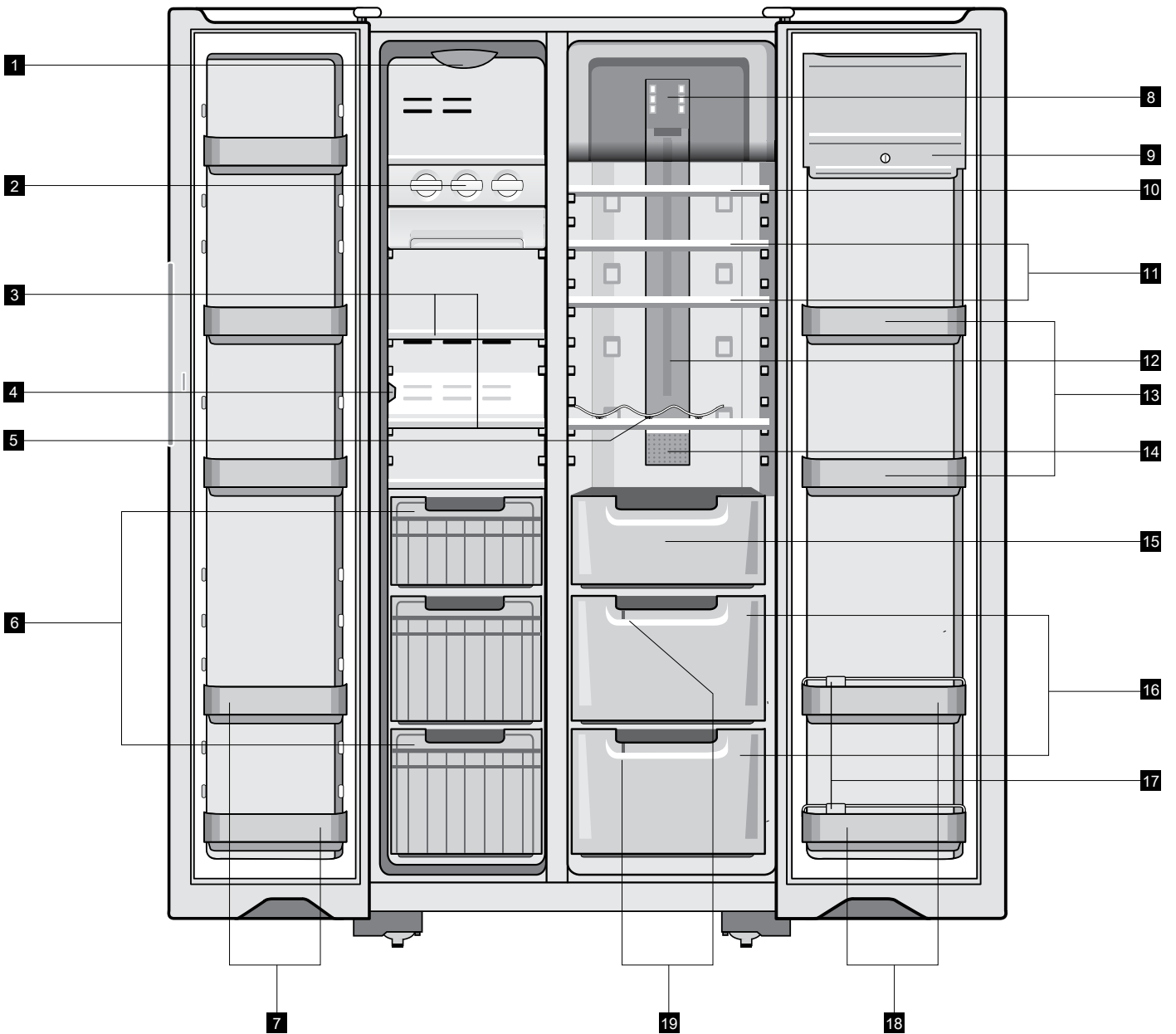

- |  |                               |
|--|-------------------------------|
| <b>1</b> Freezer lighting                    | <b>12</b> Fridge lighting     |
| <b>2</b> Twist ice & serve drawer            | <b>13</b> Adjustable door bin |
| <b>3</b> Slide out glass shelves             | <b>14</b> Sensor & deodoriser |
| <b>4</b> Freezer temperature sensor          | <b>15</b> Deli compartment    |
| <b>5</b> Bottle caddy                        | <b>16</b> Crisper bins        |
| <b>6</b> Freezer baskets with clear fascia   | <b>17</b> Bottle twist holder |
| <b>7</b> Adjustable door bins                | <b>18</b> Bottle bins         |
| <b>8</b> Electronic temperature controls     | <b>19</b> Humidity controls   |
| <b>9</b> Locker compartment                  |                               |
| <b>10</b> Spillsafe™ slide-away glass shelf  |                               |
| <b>11</b> Spillsafe™ slide-out glass shelves |                               |

Features may vary depending on model. Not all models will have a features list.

## ESE6977 WITH ICE AND WATER FEATURES



- |  |                                      |
|--|--------------------------------------|
| <b>1</b> Ice maker unit                      | <b>11</b> Adjustable door bins       |
| <b>2</b> Freezer lighting                    | <b>12</b> Fridge lighting            |
| <b>3</b> Removable ice bin                   | <b>13</b> Freezer temperature sensor |
| <b>4</b> Slide out glass shelves             | <b>14</b> Sensor & deodoriser        |
| <b>5</b> Bottle caddy                        | <b>15</b> Deli compartment           |
| <b>6</b> Telescopic freezer bin              | <b>16</b> Telescopic crisper bin     |
| <b>7</b> Adjustable door bins                | <b>17</b> Bottle twist holder        |
| <b>8</b> Dairy compartment                   | <b>18</b> Bottle bins                |
| <b>9</b> Spillsafe™ slide-away glass shelf   | <b>19</b> Humidity controls          |
| <b>10</b> Spillsafe™ slide-out glass shelves |                                      |

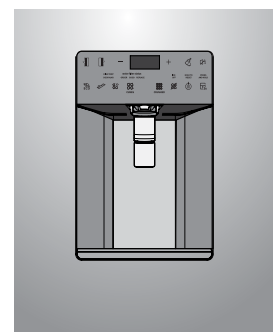

Electronic temperature controls + ice and water controls on freezer door

Features may vary depending on model. Not all models will have a features list.

## ESE7007 WITH STANDARD FEATURES

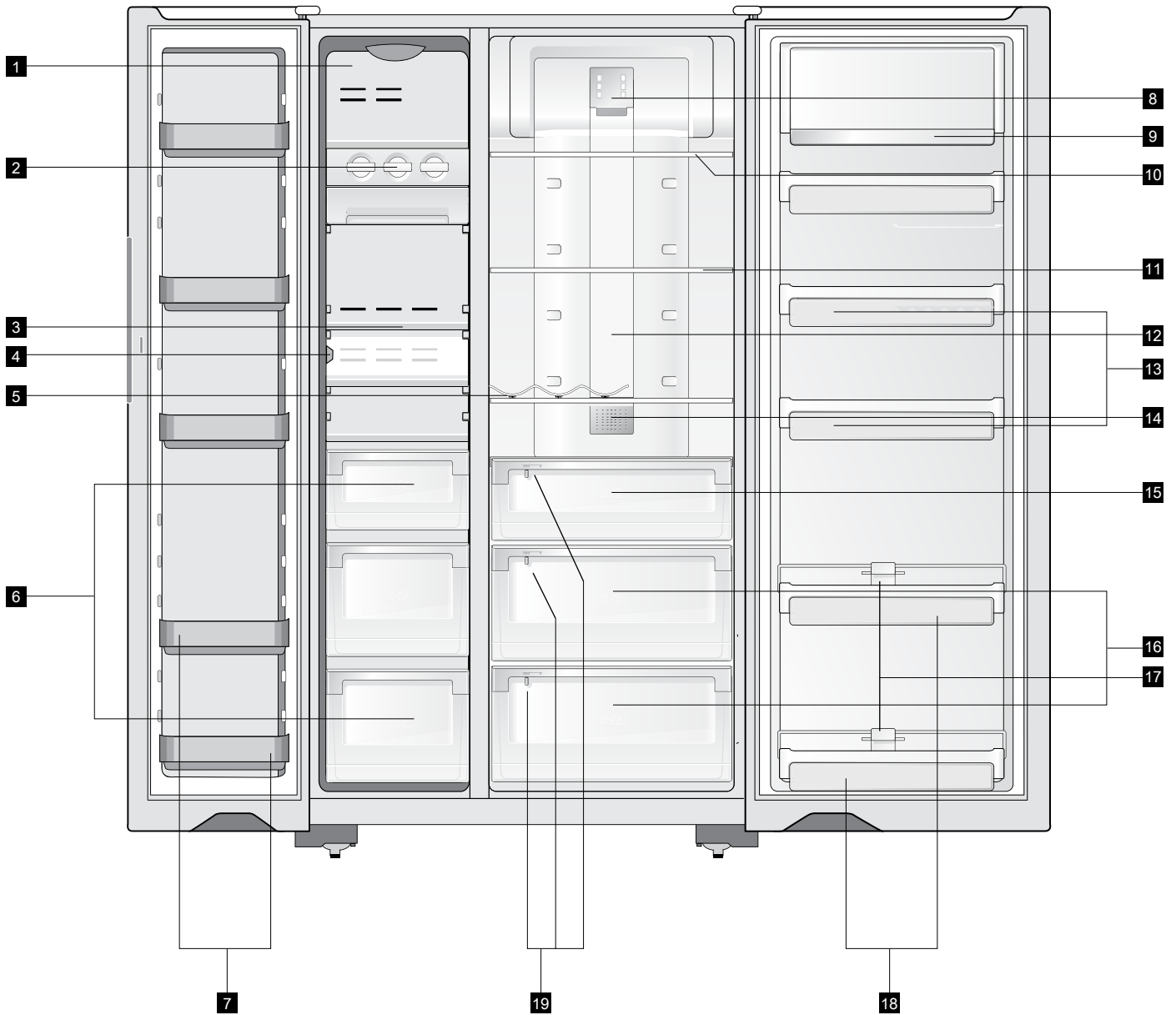

- |  |                                   |
|--|-----------------------------------|
| <b>1</b> Freezer lighting                    | <b>12</b> Fridge lighting         |
| <b>2</b> Twist ice & serve drawer            | <b>13</b> Adjustable door bins    |
| <b>3</b> Slide out glass shelves             | <b>14</b> Sensor & deodoriser     |
| <b>4</b> Freezer temperature sensor          | <b>15</b> Deli compartment        |
| <b>5</b> Bottle caddy                        | <b>16</b> Telescopic Crisper bins |
| <b>6</b> Telescopic freezer bins             | <b>17</b> Bottle twist holder     |
| <b>7</b> Adjustable door bins                | <b>18</b> Bottle bins             |
| <b>8</b> Electronic temperature controls     | <b>19</b> Humidity controls       |
| <b>9</b> Dairy compartment                   |                                   |
| <b>10</b> Spillsafe™ slide-away glass shelf  |                                   |
| <b>11</b> Spillsafe™ slide-out glass shelves |                                   |

Features may vary depending on model. Not all models will have a features list.

## ESE6077 WITH ICE AND WATER FEATURES

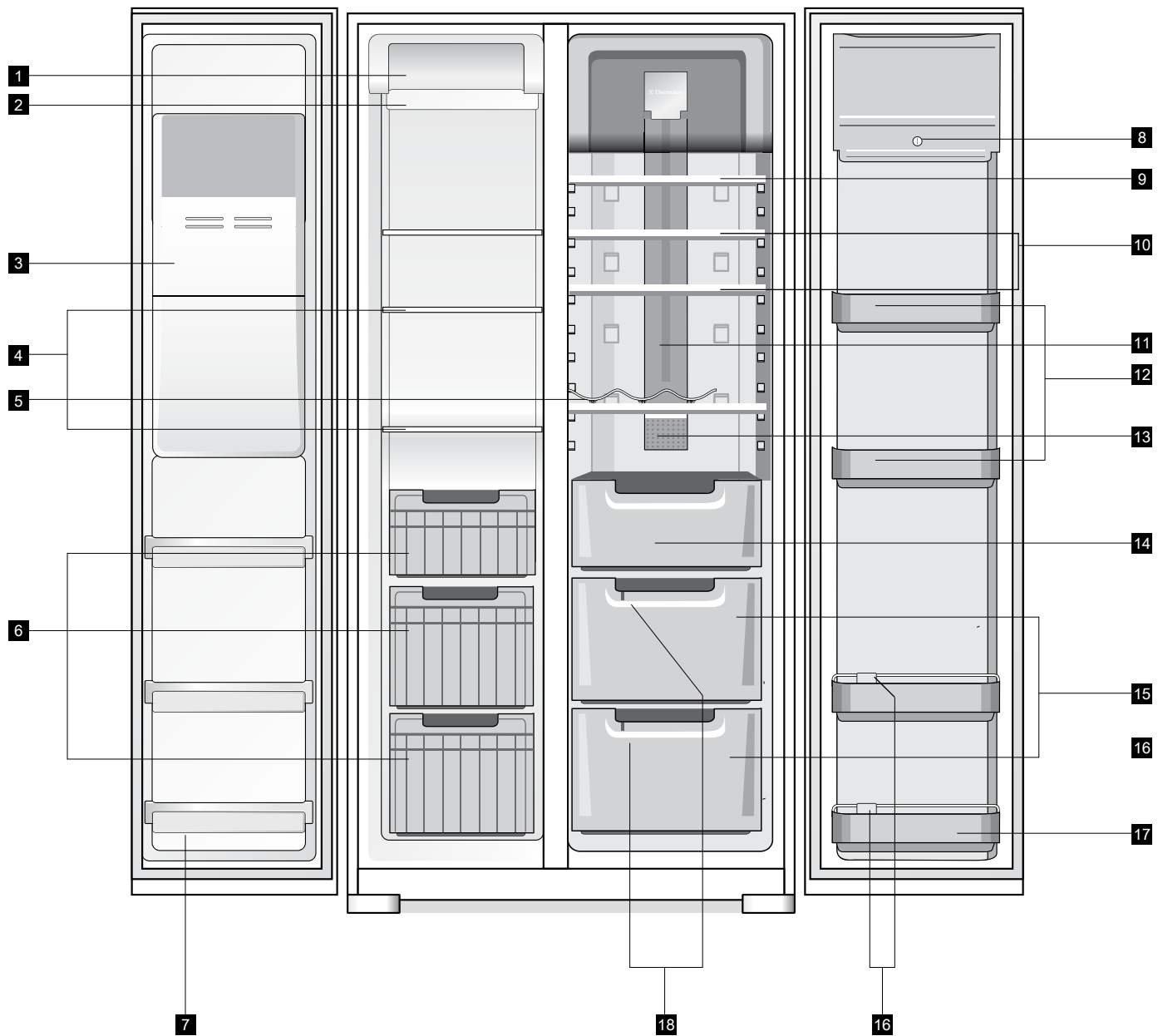

- |  |                                |
|--|--------------------------------|
| <b>1</b> Ice maker unit                      | <b>12</b> Adjustable door bins |
| <b>2</b> Freezer lighting                    | <b>13</b> Sensor & deodoriser  |
| <b>3</b> Removable ice bin                   | <b>14</b> Deli compartment     |
| <b>4</b> Slide out glass shelves             | <b>15</b> Crisper bins         |
| <b>5</b> Bottle caddy                        | <b>16</b> Bottle twist holder  |
| <b>6</b> Freezer basket with clear fascia    | <b>17</b> Bottle bins          |
| <b>7</b> Adjustable door bins                | <b>18</b> Humidity controls    |
| <b>8</b> Locker compartment                  |                                |
| <b>9</b> Spillsafe™ slide away glass shelf   |                                |
| <b>10</b> Spillsafe™ slide-out glass shelves |                                |
| <b>11</b> Fridge lighting                    |                                |

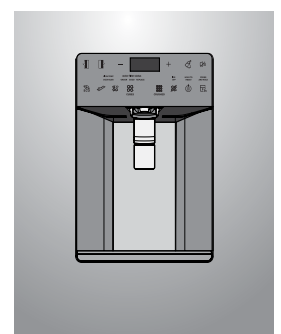

Electronic temperature controls + ice and water controls on freezer door

Features may vary depending on model. Not all models will have a features list.

## INSTALLATION

When correctly installed, your refrigerator should:

- Have adequate clearance to the back, sides and top for air circulation
- Be aligned to the surrounding cupboards
- Have doors that will self close from a partially open position

### Clearances around your refrigerator

Your side by side refrigerator can be installed between cupboards or fixtures but you must allow for the following spaces around the cabinet.

- Allow a minimum of 5 millimetres clearance on both sides (see diagram 1)
- Allow a minimum of 5 millimetres clearance above hinge covers (see diagram 1)
- Allow 10 millimetres clearance at the back of the refrigerator (see diagram 1)

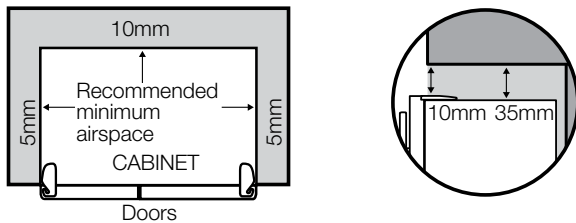

Diagram 1

- Allow a 250 to 350 millimetre minimum clearance on the hinge side of the doors, if you place the refrigerator next to the wall. This will make cleaning easier (refer to diagram 2)
- Make sure that cupboards or fixtures do not stick out further than the refrigerator cabinet (refer to diagram 2)

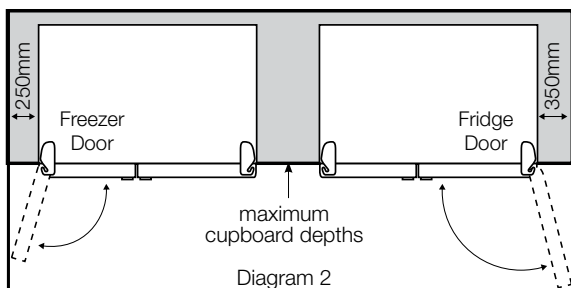
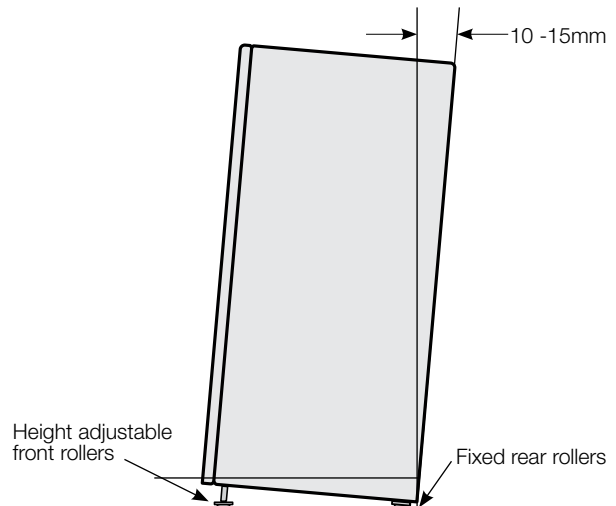

Diagram 2

The refrigerator should arrive with the front rollers wound down. We recommend that the appliance be tilted backwards by about 10 to 15 millimetres, this will allow the doors to self close providing a consistent door seal. To do this follow the instructions below.



When you want to install your appliance, take the following steps.

1. Roll the refrigerator into it's final position.

### ! CAUTION!

**The rollers are designed for forward or backward movement only. They are not castors. Moving the refrigerator sideways may damage your floor and the rollers.**

2. If the refrigerator is not tilted back you can adjust the two front rollers by adjusting the large plastic roller nut (refer to 'Adjusting door alignment' section). You may need two people, one to adjust rollers and one to tilt the refrigerator slightly back to take the weight of the appliance off the front rollers. This will increase or decrease the height of the rollers. One turn of the nut will change the tilt of the refrigerator by approximately 5mm.

## INSTALLATION

- If the cabinet is level, then the side walls should be plumb or vertical. If the cabinet is built in or partly built in check the alignment of the cabinet side against the cupboard.

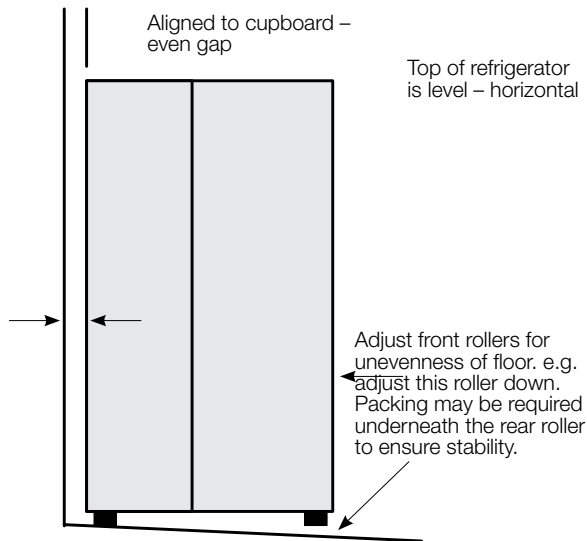

- If the appliance now rocks from one corner to the opposite rear corner, this means that the floor is uneven; you will need to put some packing under one of the rear rollers.
- You may now need to fine-tune the installation by adjusting the front rollers once again.

### Adjusting the door alignment

Each door is independently adjustable in the vertical direction by turning the adjustable bolts under the hinges using the spanner provided.

The doors can be adjusted up or down. Depending on the amount of adjustment required it may be sufficient to adjust only one door (refer to following diagrams).

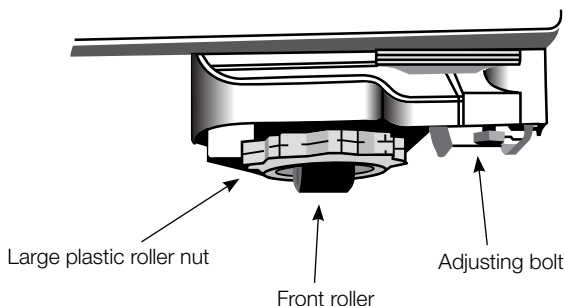

**NOTE:** When the height of the rollers and adjusting bolts are correctly adjusted the refrigerator will stand firmly on the floor and the doors will be in line with one another.

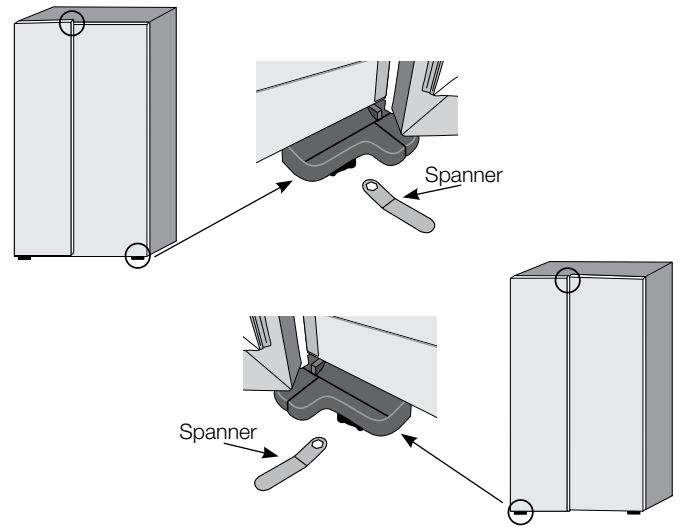

### Internal packaging

- Please remove all internal packaging material before use. Any glue or tape residue or the like should be removed with a solution of mild detergent and water.
- Clean your appliance thoroughly following the instructions in the 'Cleaning your refrigerator' section and wipe off any dust that has accumulated during shipping.
- It is recommended that the refrigerator is kept upright at all times. However if for any reason the refrigerator is laid down, let it stand for a minimum of 1 hour before turning on.

### **! WARNING!**

**Before cleaning: Remove the power cord from the power socket. This will make sure there is no chance of getting an electric shock.**

- Install accessories such as the egg tray. The accessories are packed together to prevent damage during delivery.
- Plug your appliance into the power point.
- We recommend that you let your refrigerator run for two to three hours before you put any food in it. This will allow you to check that it is operating properly and that enough cool air is circulating.



## ICE & WATER INSTALLATION

### The external water filter kit

An external water filter and connection kit has been supplied for use with your ice & water refrigerator. The external filter design allows more space within the refrigerator and provides double the life of previous filters reducing the cost of replacement.

The filter is designed to significantly reduce chlorine, taste, odour, heavy metals, turbidity (cloudiness) and scale build up. The included plastic water tube allows quick connection to the filter and is designed for high durability and kink res used in water supplies that contain an excess of particles or other impurities. Reduced flow rate is an indication that a new filter is required. Failure to replace the filter when required can affect the function of the ice maker. Service calls caused by a failure to replace the filter are not covered by warranty.

### Contents of kit – install kit with pressure reducing valve.

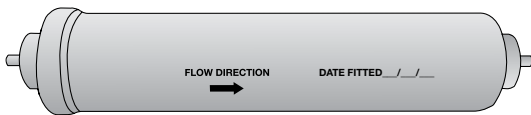

1 x water filter with push fit connections

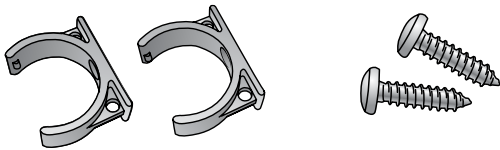

2 x mounting brackets and screws

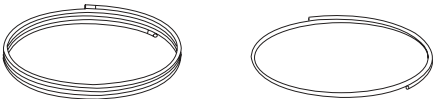

4 + 1 metres of water tubing

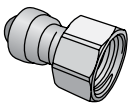

1 x 1/2" tap fitting



2 x circlips

### Please read before beginning installation

The water connection to your ice and water product can be self-installed. It is recommended that you seek advice from a licensed plumber (if necessary) before commencing the installation.

### WARNING!

**Your warranty may be voided by an incorrect installation**

### Water supply and plumbing

A drinkable water supply to suit a 1/2" tap fitting is required adjacent to the refrigerator. It is recommended that a licensed plumber install a new water supply outlet nearer to the appliance should the tubing supplied not be long enough. It is not recommended that the tubing be extended as this could adversely affect the flow of water to the ice maker or water dispenser.

The water dispenser and automatic ice maker require a drinkable water supply with a pressure range of between 206kPa and 689kPa (30PSI and 100PSI). If the water supply pressure is below 206kPa (30PSI) then a separate pump will need to be installed.

It is recommended that a Noise Reduction Valve also be fitted in the water supply line. This will reduce water hammer and its effects from quick action house hold taps and fast acting valves on appliances. The refrigerator water valve is pre-fitted with a push-fit connector for inserting the water tube. Where the tap connection is other than 1/2" adapters can be purchased from plumbing supply stores or good hardware stores.

### Water filter

Locate the water filter as close as possible to the water supply tap in a vertical position where possible. The filter will need to be replaced every 12 months to prevent excess filtered micro-organism build-up, and thus ensure continuous purified water and ice supply for you and your family. Replacement water filters are available from Electrolux Home Products Spare Parts Centres and can be posted to you for your convenience (refer to back page for contact details).

### WARNING!

**If the appliance is not connected to a water supply ensure that the ice maker is switched off (refer to STEP 1 overleaf). If you don't do this a loud buzzing noise will be heard intermittently. The new hose-sets supplied with the appliance must be used and old hose-sets should not be reused. Do not use with water that is microbiologically unsafe or with water of unknown quality without adequate disinfection. Never connect the appliance to a hot water supply. Never install the water filter in an area of the wall where there may be electrical wires and/or water supply pipes.**

## ICE & WATER INSTALLATION

### **! CAUTION!**

**Never install the water filter in an area of direct sunlight.**

**Check for water leaks at all water connection points in the first 2 to 3 hours after installation, and correct it in case of any water leak. Recheck after 24 hours; if leak still occurs, it is recommended to turn off water supply and contact a licensed plumber for advice.**

Water is to be connected as per diagram below.

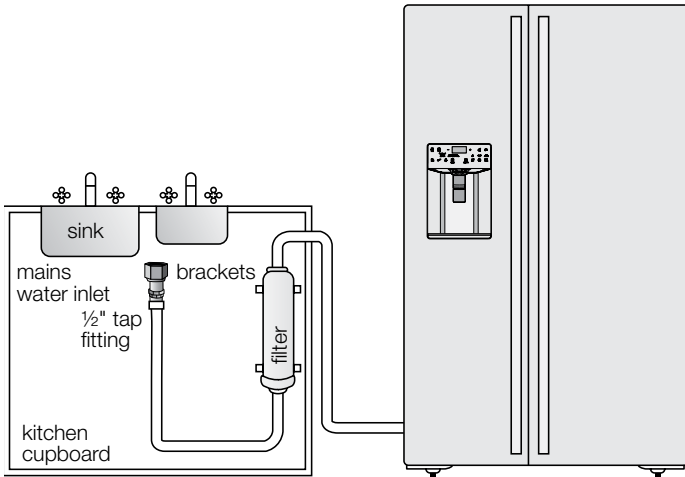

### **Step 1.**

Ensure that the Ice Maker is switched OFF.

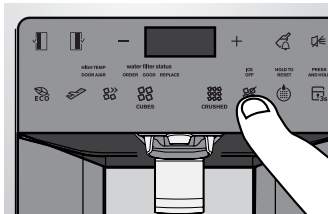

### **Step 2.**

Disconnect refrigerator from power supply.

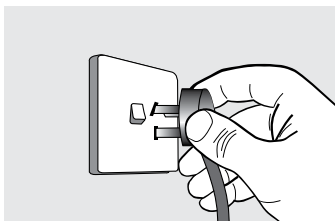

### **Step 3.**

Connect tap fitting to water supply tap. Tap must be close to the refrigerator.

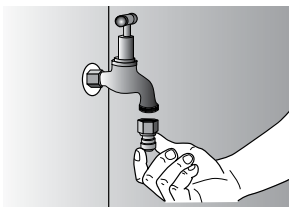

### **Step 4.**

Install brackets for filter close to tap. Plan to leave as much tubing as possible behind the refrigerator to enable it to be moved easily for cleaning or service.

### **! CAUTION!**

**Do not screw the brackets into the refrigerator as this may void your warranty and permanently damage the refrigerator.**

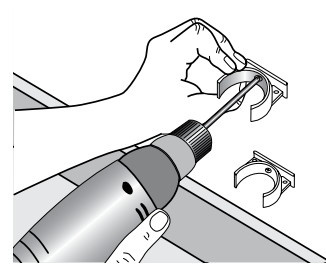

### **Step 5.**

Write date on filter. The filter will need to be replaced every 12 months.

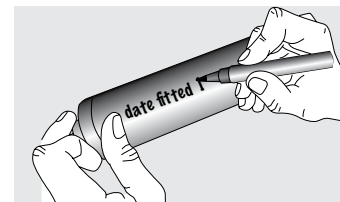

### **Step 6.**

Extend the red collar and clip a circlip around the collar at both ends of the filter.



### **Step 7.**

Fit filter to brackets with water flow arrow pointing up.

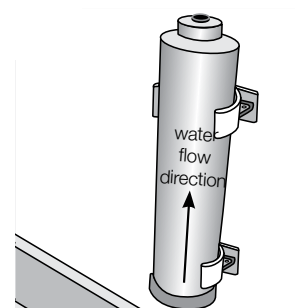

## ICE & WATER INSTALLATION

### Step 8.

Push shorter tube into tap fitting past insertion mark.

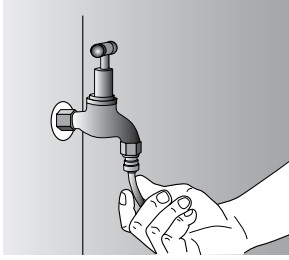

### Step 9.

Push other end into filter INLET.

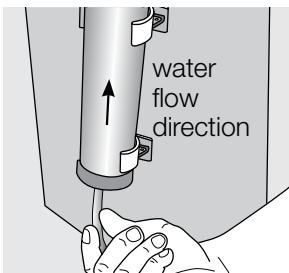

### Step 10.

Connect remaining tube length into filter OUTLET.

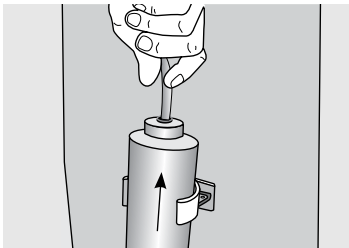

### Step 11.

Connect other end of remaining tube length to inlet on bottom right hand side of refrigerator back.

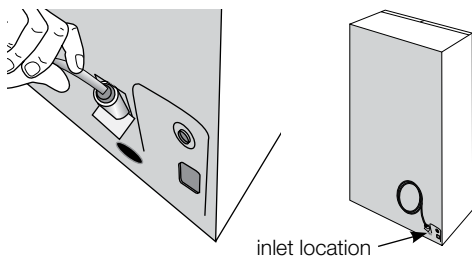

Ensure black circlip is fitted to the valve on the rear of the fridge when making this connection.

### Step 12.

Turn on water and check all joints and tubes for leaks.

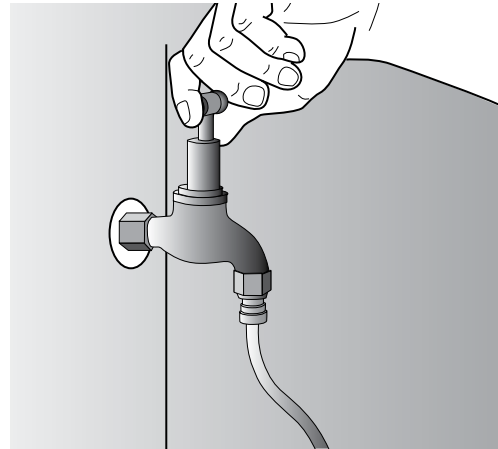

### Step 13.

Reconnect the power.

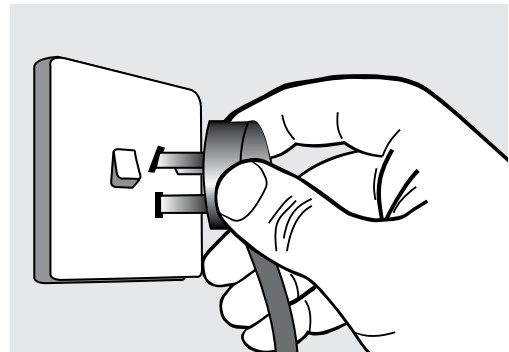

### Step 14.

Move the refrigerator back into place being careful not to kink or split the tubing.

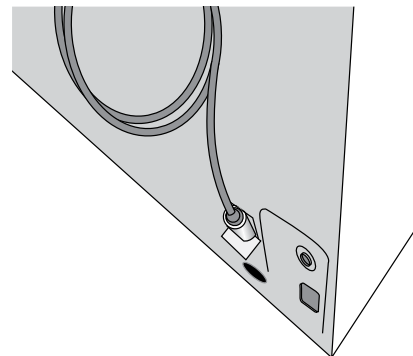

## ICE & WATER INSTALLATION

### Step 15.

Using a large container run the water dispenser to clear air from lines. This may take a few minutes. Purge and dispense a minimum of 2 litres of water or until the water runs clear. Initial water may be black in colour. This is residual carbon dust from the filter and is non-toxic. If the water is slow to shut off or the dispenser is dripping, air may still be in the lines. Either purge more water through the system to remove this air or allow some time for the air to be removed over subsequent dispensing.



### Step 16.

Switch ON Ice Maker.

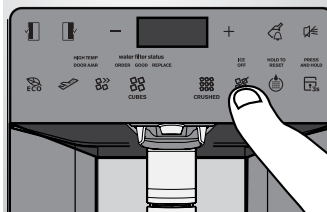

### Step 17.

After 24 hours remove ice bin and dispose of first few batches of ice to ensure that impurities have been flushed from the system.

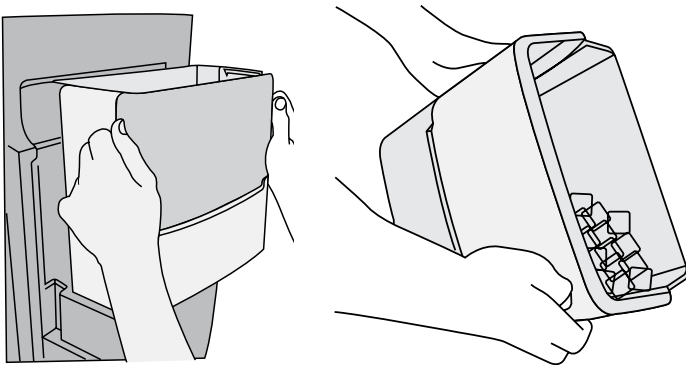

### Tips and Useful Information

- ✓ Ensure that taps are turned off when replacing and fitting filters. Remember to turn the taps back on when filter fitting is complete.
- ✓ Always fit filter as per manufacturer's instructions, paying special attention to water flow direction.
- ✓ If you need to replace water tube, only use approved water quality piping that meets the pressure requirements.
- ✓ Do not allow the water tubing to become kinked or trapped under the refrigerator when moving the refrigerator back into position.
- ✓ Make sure your refrigerator is level to avoid uneven or oversize cubes. Uneven ice cubes may lead to the dispenser chute becoming blocked.
- ✓ After installation, run the water dispenser for a few minutes to ensure that all air bubbles have been purged from the tubing. Dripping may occur if air bubbles remain in the tube.
- ✓ Replace filter at suggested intervals to avoid water/ice reduction and irregularities in taste.
- ✓ Remove and clean ice bin once a month, discarding unused ice cubes. This will ensure fresh, clean ice and smooth operation of your ice maker.
- ✓ Clean and empty the dispenser drip tray regularly to avoid overflow.
- ✓ As the water/ice cut off is not instant, leave glass under dispenser briefly until water or ice has stopped flowing to avoid spills.
- ✓ Always place ice in glass before filling with water to avoid splashing.
- ✓ When dispensing ice hold the container close to the chute to avoid spray or spills.

If you have not used the dispenser for some time:

- Discard the first seven or eight cups of water
- Discard any ice that the ice maker produces in the first 24 hours (contaminants could have settled in the water pipes)

## ICE & WATER INSTALLATION

### **!** CAUTION!

**Connect to potable water supply only. Do not put fingers into ice crusher. Surfaces there may be sharp**

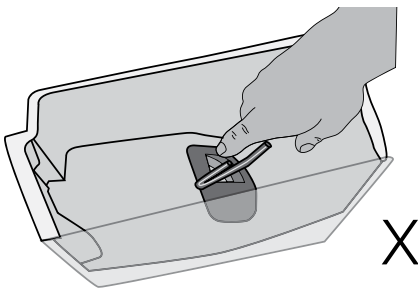
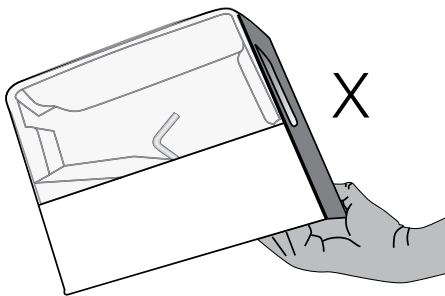
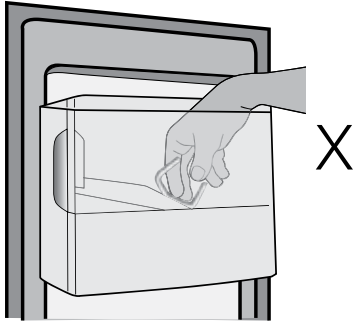

## INITIAL START-UP

### Refrigerator/freezer operation

A light frosting will occasionally occur on the interior of the freezer when the door is opened frequently. This is normal and will disappear after a few days in most climates.

Make sure you fully close the freezer door after you load or remove food. If the door is left partly open, a heavy frost will coat the inside of the freezer. If a frost develops, remove it. Take care to properly close the door and the frost will not reoccur.

Your new energy efficient appliance uses a variable-speed compressor and other energy efficient components which may produce different noises to your old appliance.

These sounds are normal and include:

- Compressor running noise
- Air movement noise from the small fan motor
- Occasional gurgling, similar to water boiling
- A popping noise, heard during automatic defrosting
- A clicking noise, just prior to the compressor starting up
- A motorised air baffle used to adjust airflow
- These noises are normal and not cause for alarm

It is normal for the rear, sides and centre divider of the appliance to feel warm. These areas are warm because the appliance transfers heat from the food placed inside to the outside air.

There is a cooling coil located behind the rear wall of the freezer section. This coil cools and removes moisture from the air. A fan at the rear of the freezer section then circulates cold, dry air throughout the refrigerator. The air circulation means that foods are refrigerated far more quickly than in refrigerators where there is less air circulation. Avoid placing food against air outlets as this will affect air circulation.

## USING YOUR REFRIGERATOR – GENERAL

### Temperature Sensors

Avoid loading food against your freezer temperature sensor. Doing so may adversely affect freezer temperatures. If warm food is inadvertently loaded against the sensor, it may also set off the freezer temperature alarm for up to 50 minutes after the food is loaded against the sensor.

*NOTE: Product illustrations demonstrate features that may not be completely in line with all current products.*



### ENVIRONMENT!

Eco and holiday modes minimise defrosting to save energy, while maintaining your temperature settings.

### Other electronic features

Your refrigerator:

- Controls the compressor and fan independently to provide the best performance
- Provides extra cooling depending on the number of door openings
- Automatically defrosts during periods when the door is not being opened frequently



### TIPS & INFORMATION!

If you find that the display malfunctions, this may be due to brief power supply interruptions. If this is the problem, you simply need to turn the refrigerator off at the power point and wait 5 minutes, then turn the refrigerator on again at the power point.

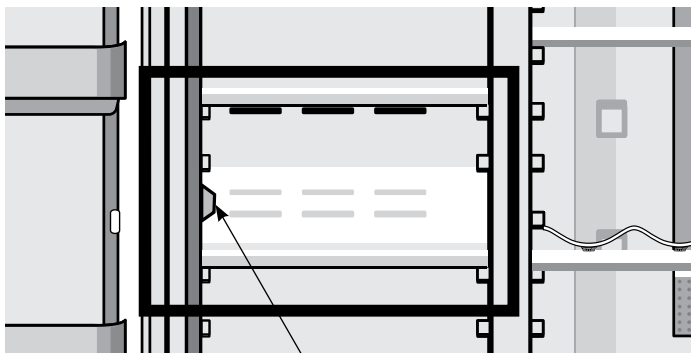
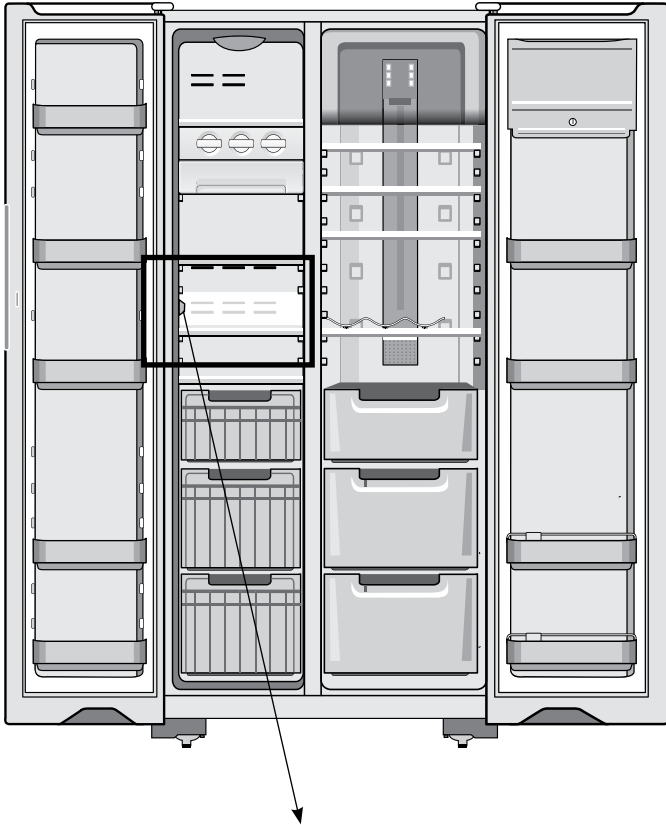

freezer temperature sensor



## FOOD COMPARTMENT FEATURES

### Door storage bins

Both the refrigerator and freezer have door storage bins. You can adjust the door bins to meet different storage needs. All the door bins can be removed for cleaning. To remove a fridge or freezer bin, lift it up from the support lugs on the inner door panel. Push the bin down over the support lugs to lock it in place.

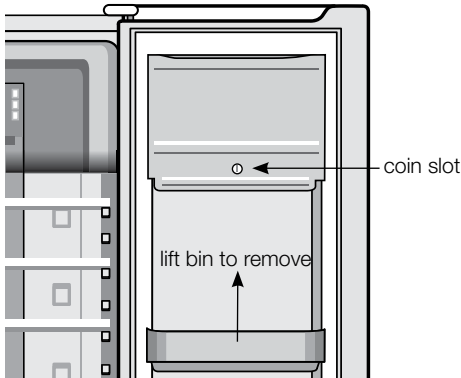

### Store safe compartment (Compact Side by Side only)

The store safe compartment (diagram above) is a coin-lockable compartment. To lock, rotate the coin slot clockwise until the slot is vertical. To unlock, turn the coin slot anti-clockwise until the slot is horizontal.

### Dairy compartment

Use the dairy compartment (690/700L Side by Side models only) to store foods like butter, margarine and cheeses.

The compartment is slightly warmer than the rest of the refrigerator compartment, while the lid provides protection against odours.

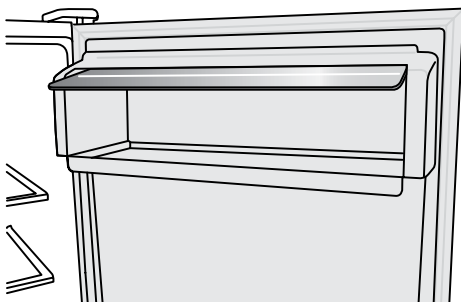

### Bottle twist holder operation

The bottle twist holder is used to prevent bottles from falling over. The twist holder consists of two parts, a sliding front, and a rotating retainer ring. The retainer ring can be rotated through 360° but has positive locations for horizontal and vertical positions. The bottle twist holder can be used in two positions:

- Horizontal – when the bottle twist holder ring is horizontal, any item that fits within the ring can simply be placed inside it.

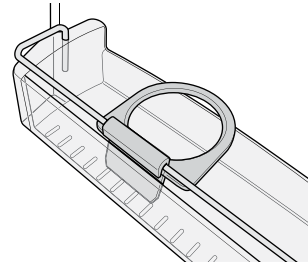

- Vertical – when the bottle twist holder ring is vertical, it is possible to simply slide the bottle twist holder along the bottle retainer bar until it is pushed up against a bottle.

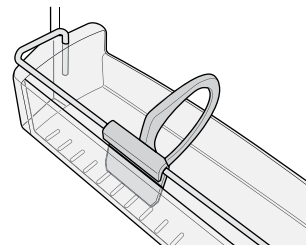

*Note: The bottle should be constrained on the other side by either the end of the bin or other adjacent bottles.*

### Crisper bin(s)

- Storing vegetables

You can use the crisper bin to store vegetables, fruit or small goods. You can change the humidity inside the bin by sliding the humidity control.

You should store vegetables in the crisper bin remembering to set the humidity control to more humid.

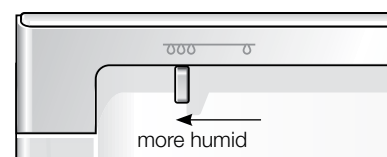

- Storing fruit & small goods

You can also store fruit & small goods in the crisper bin remembering to set the humidity control to less humid.

### ! CAUTION!

**To clean a crisper cover with telescopic extension slides, simply wipe with a damp cloth and warm soapy water. Never immerse the cover in water, as this could affect the operation of the slide.**

### Telescopic freezer bins and crispers

For large side by sides with telescopic freezer bins and crispers you can replace the drawer as follows:

1. Push the telescopic slides in all the way.
2. Slide the drawer into place over the slides and push the bin in until it stops. The bin will not be closed all the way.

## FOOD COMPARTMENT FEATURES

Open the bin to access the finger tabs at the ends of the telescopic slides, on each side of the bin. Using your thumb and forefinger, lift the bin over the end of the slide and clip in place. If the drawer is not fully engaged on the slide, it's possible the drawer won't stay on the slide if fully extended.

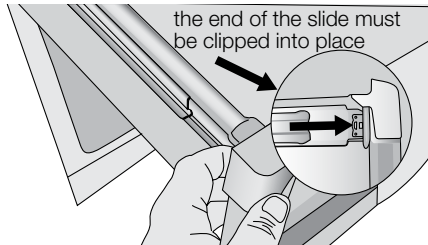

3. Fully close the bin.  
When replacing the drawers after cleaning, we recommend fitting the lower drawer first.

### Freezer baskets

Wire baskets are used in the compact side by side model. All the baskets pull out for easy access and have a stop to prevent the basket being pulled out too far.

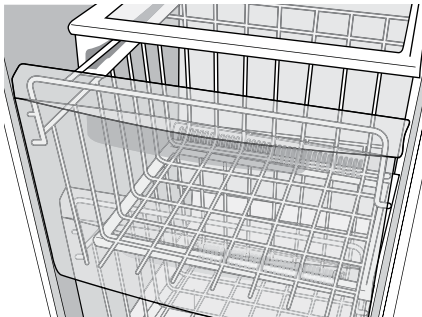

To remove the basket, pull it out until it hits the stop then lift the front to unhook the stop while continuing to pull forward, until the basket is free of the runners under the shelf.

### Deodoriser

Your appliance is fitted with a deodoriser to assist with the removal of food odours inside your appliance. (Refer item 14).

Odours are removed by absorption through the filter by the normal operation of the appliance. Keeping food covered and wrapping food with plastic wrap will also help to reduce the odours inside your appliance.

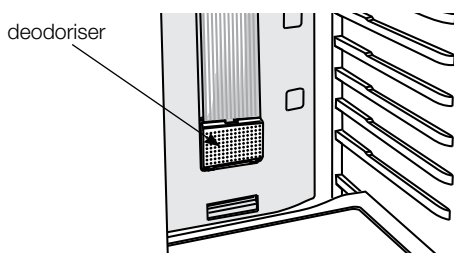

### Bottle caddy

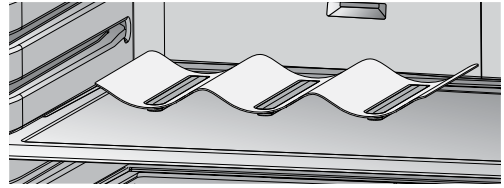

The bottle caddy is made of stainless steel. It is used to store various types of bottles like wine or beer. Bottles should be stored with the bottom end towards the back of the refrigerator.

### Slide away glass shelf

This shelf can be used either as a full depth shelf or when tall items need to be stored at the front of the appliance it can be collapsed to half its original depth.

- To collapse the shelf:

1. To release the front half of the shelf, pull the front section of the shelf forward whilst pushing the rear edge of the front section up.

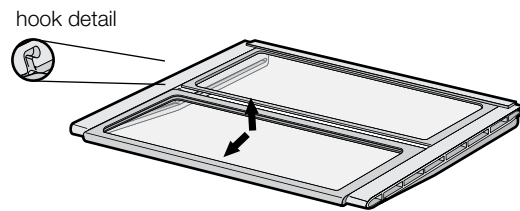

2. Pull the shelf forward and allow the rear to drop into the side channels.

3. Push the front shelf backwards until it reaches the rear stops.

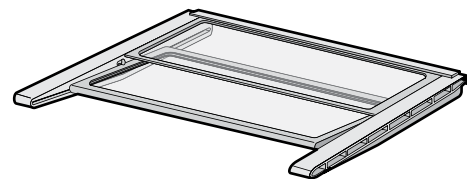

4. Repositioning:  
To reposition shelf, pull forward until shelf reach stops. Lift shelf clear of stops and continue to pull forwards. Once the shelf is clear of the cabinet it can be repositioned onto any of the other runners.

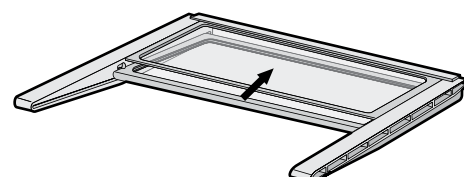

## ICE & WATER FEATURES (WHERE FITTED)

### Twist ice & Serve

To use, remove the tray, fill with water and place back in the freezer. Once ice has formed (approximately 3 hours) simply twist the knob at the front clockwise until the ice drops into the bin below.

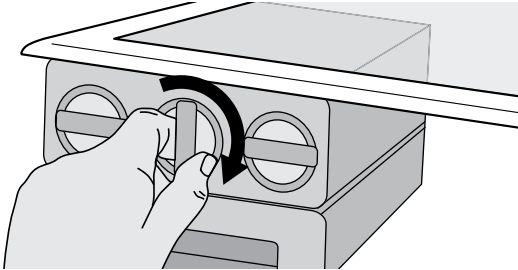

### Ice & water dispenser features

The ice and water dispenser conveniently dispenses cool, filtered water and ice cubes or crushed ice. To operate the ice dispenser, select an ice option using the electronic display and press glass against ice dispensing paddle. To stop dispensing ice, pull the glass away from the ice dispensing paddle.

Remove the glass from the dispenser paddle when it is approximately half full. Ice already in the chute may cause the glass to overflow or back up into the chute and cause a blockage (refer to troubleshooting guide on how to unblock the ice chute).

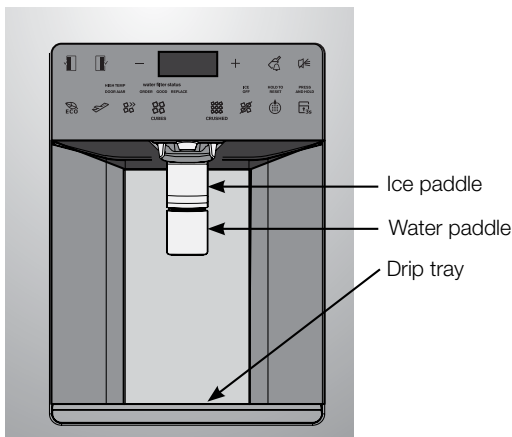

To operate the water dispenser, press a glass against the dispensing paddle. To stop dispensing water, pull the glass away from the water dispensing paddle. A drip tray located at the base of the dispenser (see diagram above) will catch small spills and allow them to evaporate. The drip tray is removable and dishwasher safe. Opening the freezer door will de-activate the ice dispenser.

### ⚠ CAUTION!

**Do not pour water or excess cubes into the drip tray because it is not connected to a drain.**

### ⚠ WARNING!

**Do not use fragile glass for dispensing water or ice – as there is a risk of injury from broken glass.**

### Bottle filling function

The bottle filling function facilitates the flow of water directly into the mouth of a bottle, minimising splashing and spillage. Water flows from the water dispensing nozzle located on the underside of the ice and water dispenser.

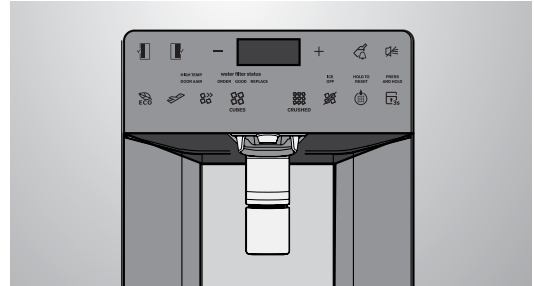

To use this function, place the mouth of the bottle over the water dispensing nozzle.



Once the mouth of the bottle is completely over the water dispensing nozzle (see diagram below) gently push bottle up to dispense water and fill bottle. Once the bottle is full, remove the bottle and the flow of water will stop automatically.



## ELECTRONIC DISPLAY PANEL

### ESE6107 and ESE7007 models

The electronic display panel consists of an LCD display with backlighting and 6 buttons. When the power is first turned on, the display with backlighting will come on. If no buttons have been pressed and the fridge door is closed the backlighting will turn off after 30 seconds.

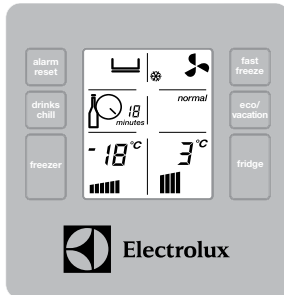

*NOTE: Depending on the model, if no buttons are pressed for approximately 60 seconds, there may be a delay of up to 2 seconds before the display reacts. This is normal and is to prevent accidental changes to settings.*

### Controlling the temperature

We recommend that when you start your refrigerator for the first time, the temperature for the refrigerator is set to 3°C and the freezer to -18°C. If you want to change the temperature, follow the instructions below. Make only small adjustments and wait 24 hours to see if it's correct. Checking the softness of ice cream is a good indication if your freezer is the right temperature, while checking the temperature of water kept in the refrigerator is a good way of checking the temperature of the food compartment.

*Note: When you set a temperature, you set an average temperature for the whole refrigerator cabinet. temperatures inside each compartment may vary, depending on how much food you store and where you place it. High or low room temperature may also affect the actual temperature inside the refrigerator.*

### Changing the freezer temperature

Press the freezer button to make the freezer colder in 1°C steps. Once the maximum of -23°C is reached, the display will return to -14°C with the next press of the button. The bar graph gets smaller with colder freezer settings.



### Changing the refrigerator temperature

Press the fridge button to make the refrigerator colder in 1°C steps. Once 0°C is reached, the display will return to 7°C with the next button press. The bar graph gets smaller with colder refrigerator settings.



### Fast freeze function

Use the fast freeze function when you add a large amount of food to the freezer compartment. This freezes the food quickly but does not affect the temperature in the refrigerator compartment. To use this function, press the fast freeze button once. An animated icon will light up. The fast freeze function will now operate for 90 minutes. If you want to turn the fast freeze function off before 90 minutes have passed, simply press the fast freeze button again. The icon will disappear and the freezer will return to normal operation.



### Freezer temperature alarm

If the alarm sounds for no apparent reason, check whether anything is keeping the door open. If the freezer becomes too warm due to the freezer door being left open or warm food being placed too close to the temperature sensor, a buzzer will sound. The icon adjacent to the alarm reset button, the freezer set temperature and bar graph will all flash, until the alarm reset button is pressed. Once pressed, the alarm disable icon adjacent to the alarm button will illuminate for 50 minutes, or until the temperature drops to an acceptable level. Make sure nothing is holding the freezer door open and move any warm food away from the temperature sensor. If the freezer is still too warm after 50 minutes, the alarm will sound again, indicating that something may be wrong with the refrigerator.

*Note: the freezer temperature alarm can be reset for 12 hours by pressing the alarm reset button continuously for 10 seconds.*

### Door alarm

If the fridge door is left open for more than two minutes, the alarm will buzz and an arrow pointing to an open door will flash, along with the temperature setting and bar graph. If you want to leave the door open while you load the refrigerator, you can turn the alarm off for 8 minutes by pressing the alarm reset button.

### Child Lock

Depending on the model, press and hold the freezer and fridge buttons together or the alarm reset and fast freeze buttons together, and hold to activate the child lock. This will disable the display to prevent accidental changes to settings. To turn the child lock off, press and hold the same buttons used to turn child lock on.

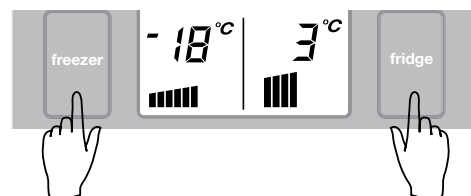

## ELECTRONIC DISPLAY PANEL

### Drinks chill timer

The drinks chill timer is used to quickly chill a bottle. Place the bottle in the freezer and the timer can be set for a minimum of 5 minutes to a maximum of 30 minutes. To set, simply press the drinks chill button repeatedly for the number of minutes (in 5 minute intervals). Once set, an animated icon appears beside the drinks chill button, with a timer that counts down one minute at a time. You can change the time or turn the timer off even after the countdown has started. A buzzer will tell you when the time is finished and the icon will flash until the alarm reset button is pressed.



If your drink is not cold enough, reset the drinks chill function (remembering the drink is already partially chilled). Suggested chilling times:

- 10 minutes for cans of drink
- 20 minutes for bottles of wine
- 30 minutes for bottles of soft drink.

### CAUTION!

**Ensure that bottles are not left in the freezer for longer than needed as freezing may cause the bottle to break.**

### Energy efficiency

Your refrigerator has been designed to be energy-efficient and can operate in three modes: normal, eco and vacation.

### Normal mode

Normal mode is used when the refrigerator door is often opened. It's the default mode of your refrigerator.

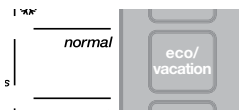

### Eco mode

Eco mode is a more efficient mode than normal mode and will activate automatically or can also be manually activated.

When activated the leaf icon will appear on the display.

Automatically: Eco mode is automatically activated if the refrigerator doors have not been opened for 30 hours. If eco mode is entered automatically the appliance will revert back to normal mode when the refrigerator door is opened.

Manually: Touching the 'eco/vacation' button once will activate eco mode. If eco mode is entered manually opening the door will not cause the appliance to revert back to normal mode. To exit eco mode press the 'eco/vacation' button until the word 'normal' is displayed.



### Vacation mode

Vacation mode is designed for maximum energy efficiency when you will be away from your appliance for an extended period. Vacation mode is activated by pressing the 'eco/vacation' button until the aeroplane icon appears. Vacation mode is exited by pressing the 'eco/vacation' button until the word 'normal' is displayed or when the refrigerator door is opened.



### Other special refrigerator features (electronic models only)

- Independent control of the compressor and fan to provide the best performance.
- Extra cooling depending on the number of times the door is opened.
- Automatic defrost when the door is not frequently opened.

*Note: Display malfunctions may be due to brief power supply interruptions. If this occurs, turn the refrigerator off at the power point and wait 5 minutes, then turn the refrigerator on again.*



## ELECTRONIC DISPLAY PANEL

### ESE6077 and ESE6977 models

When the power is first turned on the default settings are -18°C, 3°C with the 'cubed ice' icon on and 'icemaker off'. We recommend that when you start your refrigerator for the first time, the temperature of the refrigerator is set to 3°C and the freezer to -18°C. If you want to change the temperatures, use the instructions below. You should make only small adjustments and wait 24 hours to ascertain whether further adjustments are necessary.

*Note: The set temperature for the refrigerator is an average temperature for the whole cabinet. Temperatures inside each compartment may vary depending on how much food is stored and where it is placed. High or low ambient temperature may also affect the temperature inside the refrigerator.*

### Adjusting the compartment temperature

#### - Freezer Compartment

Touch the 'freezer temp.' icon & press the '-' or '+' button to change the freezer temperature in 1°C decrements from -14°C to -23°C.

If the freezer temperature is set to -14°C or above, the bar graphic will flash continuously to indicate that the temperature is too warm for long term storage of food.

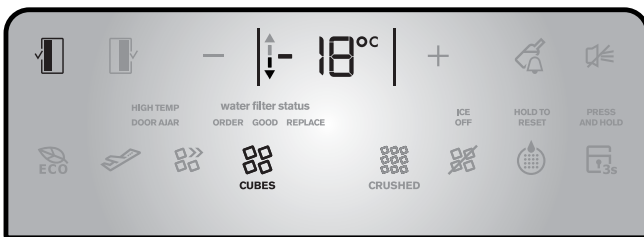

#### - Food Compartment

Touch the 'fridge temp.' icon & press the '-' or '+' button to change the refrigerator temperature in 1°C steps from 0° to +7°C.

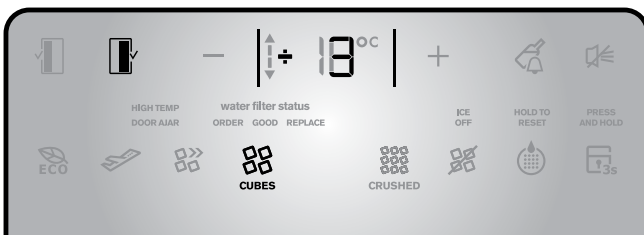

### Energy efficiency

Your appliance has been designed with energy efficiency in mind and can operate in three modes (normal, eco or vacation) depending on the level of efficiency sought.

#### • Normal mode

This is the mode which is entered automatically when the appliance is first turned on. Normal mode is the mode most suitable when the refrigerator door is opened often.

#### • Eco mode

Eco mode is a more efficient mode than normal mode and will activate automatically or can also be manually activated.

When activated the leaf icon will appear on the display. Automatically: Eco mode is automatically activated if the freezer door and the fridge door have not been opened for 30 hours. If eco mode is entered automatically, the appliance will revert back to normal mode when the freezer door or the refrigerator door is opened.

Manually: Touching the 'eco' button once will activate 'eco mode'. If 'eco mode' is entered manually, door openings will not cause the display to revert to normal mode. To exit eco mode, touch the 'eco mode' icon so the icon is no longer displayed.

### CAUTION!

**Eco mode is designed to operate with minimum door opening (e.g. if used as a long term storage fridge). If turned on manually, the system will not switch back to normal mode automatically and frequent door opening in eco mode could lead to food spoilage. If frequent door opening is likely to occur switch back to normal mode.**

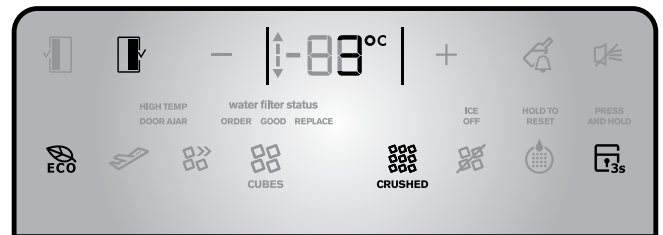

#### • Vacation mode

Vacation mode is designed for maximum energy efficiency when you will be away from your appliance for an extended period. Vacation mode is activated by touching the 'vacation' button while in normal mode. The appliance will enter vacation mode, as indicated by the aeroplane symbol. Vacation mode is exited automatically when the freezer door or fridge door is opened.

#### Fast ice

Use the fast ice function when you want to increase the speed of the ice production in the freezer compartment. To use this function touch the 'fast ice' button once. The icon will light up and the fast ice function will now be activated. The freezer compartment will drop to -23°C until the ice bin is full or a twelve hour period has passed. If you want to turn off the fast ice function simply touch the fast ice button again. The icon will disappear and the freezer will return to normal operation.

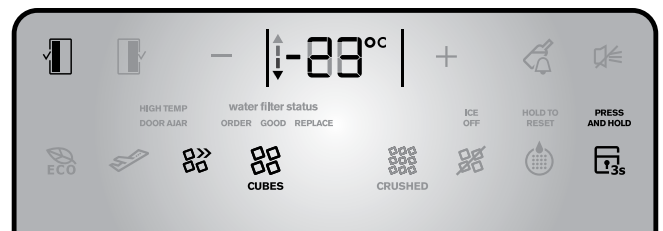





# ELECTRONIC DISPLAY PANEL

## Door alarm

If the Freezer or Fridge door is left open for longer than 2 minutes a buzzer will sound and an icon will flash. Close the door to deactivate the alarm. If you want to leave the door open while you load the fridge, the alarm can be muted for 8 minutes by pressing the 'lock' button.

-  This icon illuminates automatically if the food door is open.
  -  This icon illuminates automatically if the freezer door is open.
- DOOR AJAR This icon illuminates when either door is open.

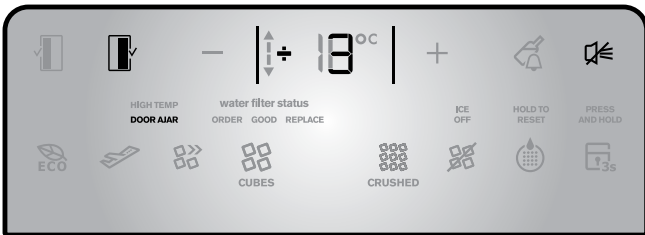

## Freezer temperature alarm

If the freezer becomes too warm, a buzzer will sound, the 'High Temp.' icon, freezer set temperature and bar graph will flash until the alarm is reset by pressing the 'lock' button.

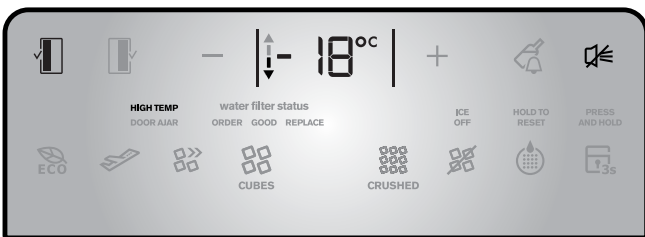

Once pressed the alarm is muted for 50 minutes but the icons will continue to flash until the temperature reaches an acceptable level. The over temperature alarm can be silenced for 12 hours by touching and holding the lock button for 10 seconds when a second beep will sound.

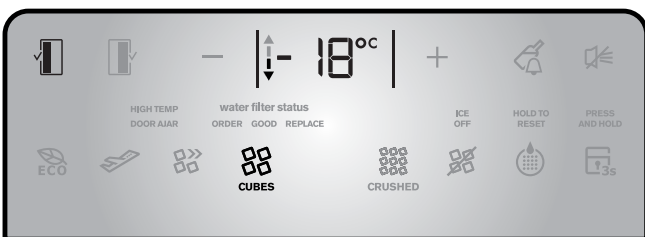

Check that the freezer door has not been left open or warm food has not been placed too close to the temperature sensor in the freezer. See diagrams in the 'components' section for the sensor location. If the freezer is still too warm the alarm will sound again in 50 minutes, indicating that something may be wrong with your refrigerator.

## Icemaker off

The automatic ice maker can be turned on and off by pressing and holding the 'ice off' icon for 5 seconds. The 'ice off' icon will illuminate on the electronic display when the ice maker is off. To turn on the ice maker simply touch the icon again. The 'ice off' icon will disappear. (2 hours after icemaker has been turned off, the ice maker will empty the ice tray but it will stop making more ice). Ice can continue to be dispensed when ice maker has been turned off.

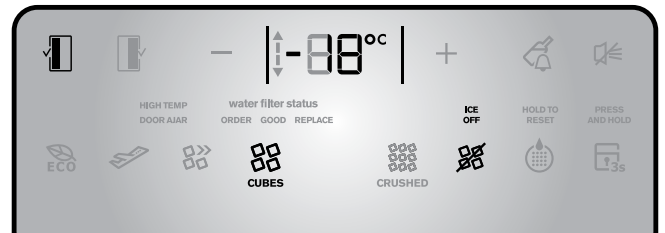

## Ice bin removed

If the ice bin has been removed or not located properly in the correct position, the 'ice off' icon will appear on the display. With the ice bin removed the automatic icemaker will stop harvesting ice and the ice dispenser system will stop. If the ice lever is pressed the console LED light will flash 3 times to indicate that the ice bin is not in place.

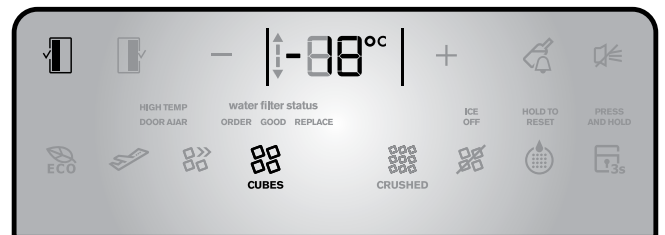

## Water filter status

You can choose whether to: 'Remind me later' by touching the 'fast ice' button, the 'Replace water filter' word will disappear but the 'Filter icon' will stay on and alarm sound will stop for 1 week. OR

Replace the filter and then press & hold filter icon for 3 seconds to reset. The alarm sound will stop, 'replace water filter' icon and 'alarm' icon and will disappear. The electronics in the refrigerator will start to accumulate the time again for the next 12 months.

## ELECTRONIC DISPLAY PANEL

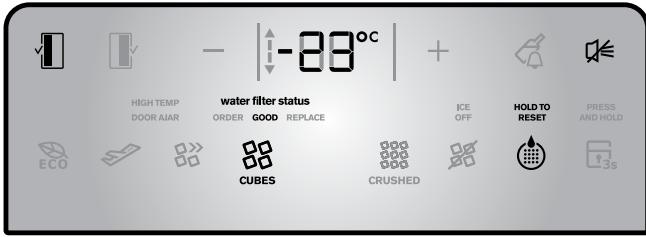

The water filter status can be checked by holding down the 'filter' icon. The display will show 'GOOD' for 48 weeks, it will then change to 'ORDER' for 4 weeks. After a twelve month period the icon will change to 'REPLACE' and an alarm will sound. The filter status will also be displayed each time ice or water is dispensed. Refer to the section on 'changing your water filter' for instructions.

### Adjusting Ice cube size

Ice cube size will vary slightly with water pressure. Ice cube size can be adjusted using the settings below. As a guide ten ice cubes should weigh between 80 and 110 grams. After adjusting, wait 48 hours before checking ice cube size.

Cube size icon	Setting	Situation
	medium (default)	normal water pressure 50 – 100 psi
	large	low water pressures 30 – 50 psi
	extra large	very low water pressure – under 30 psi (Note that this is under the recommended water pressure range)
	small	very high water pressure – over 100 psi (Note that this is over the recommended water pressure range and a pressure reducer should be fitted)

To activate the ice cube size adjustment screen press 'fast ice' and 'ice off' buttons together for 3 seconds. The 'cube size' icon and 'cubed ice' icon will flash while adjusting.

Use the 'fridge temp.' button to change the ice cube size from medium, large, extra large, small with each button press. The display will return to medium with the next button touch. To confirm or OK the setting press 'lock' button, then display returns to normal temperature display.

After 30 seconds of inactivity, display will return to normal temperature display and setting stays as previously set. Changes must be confirmed to save new setting.



### Cubed/crushed ice

The ice dispenser can deliver both cubed and crushed ice. If the icon is highlighted, cubed ice will be dispensed.

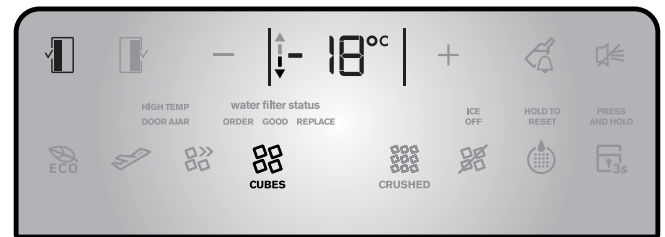

If the icon is highlighted, crushed ice will be dispensed. Switch to 'cubed ice' or 'crushed ice' by touching the 'cubed'/'crushed ice' button.

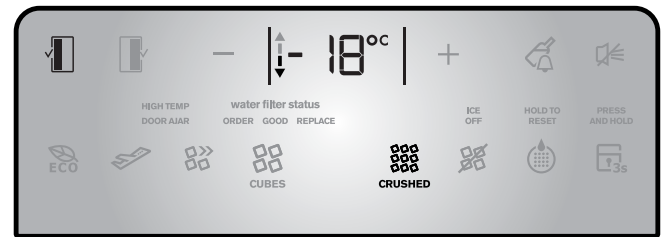

When switching between dispensing cubed and crushed ice the dispenser may still contain whole ice cubes or pieces of ice cube. These will be dispensed the next time ice is taken.

## HOW THE WATER DISPENSER WORKS

The water dispenser water tank is located behind the upper crisper bin in the refrigerator compartment.

After the refrigerator is connected to water fill the water tank by holding a large container against the dispenser paddle to run the water and clear air from lines. This may take a few minutes. Purge and dispense a minimum of 2 litres of water. Initial water may be black in colour. This is residual carbon dust from the filter and is non toxic. If the water is slow to shut off or the dispenser is dripping air may still be in the lines. Either purge more water through the system to remove this air or allow some time for the air to be removed over subsequent dispensing. The tank will automatically refill as you dispense water.

### **!** CAUTION!

**Remember, do not drink this purged water as it may have impurities in it!**

### **i** TIPS & INFORMATION!

**The water connection to your ice and water product should only be done by a licensed refrigeration mechanic, plumber or electrician.**

#### **Normal operation – for cool water, add ice.**

To provide the convenience of filtered water in the same location as the ice dispenser, it is necessary to route the tubes from the refrigerator compartment. This means the first half glass of water will not be quite as cold as the following 3 or 4 glasses. If you require cool water from the first glass, we recommend that you first add crushed or cubed ice to your glass then the water. In times of high use, water may be dispensed before it has time to cool. Once this occurs, the dispensed water temperature will be similar to that of your normal tap water until the tank has had a chance to re-cool. The addition of cubed or crushed ice will allow you to still enjoy cool water should this occur.

### **!** CAUTION!

**Chemicals from a malfunctioning softener can damage the ice maker. If the ice maker is connected to soft water, ensure that the softener is maintained and working properly.**

## HOW THE ICE DISPENSER WORKS

The ice maker is located in the top section of the freezer compartment. After installation, switch the ice maker on at the controls on the door to begin making ice. A full tray of ice may not be created for the first few batches, due to air in the refrigerator's new plumbing lines. The first batches of ice cubes may be discoloured or have an odd flavour, due to the refrigerator's new plumbing connections. Discard this ice until batches are free of discolouration or taste problems. The ice maker turns off automatically when the ice container is full. To stop ice production, turn the ice maker off at the electronic display on the door.

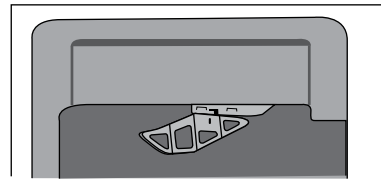

*NOTE: During the normal operation of the icemaker, the ice detecting arm is lowered to detect the level of ice in the bin (see diagram above). At times, this may be visible when the door is open.*

### **i** TIPS & INFORMATION!

- Ice cubes stored too long may develop an odd flavour. Remove the ice container and discard the ice cubes.
- Occasionally shake the ice container to keep ice separated.
- After you take delivery of the refrigerator, keep the ice maker switched off at the controls on the door until the refrigerator is connected to the water supply. The switch should also be kept in the OFF position whenever the water supply is turned off.

### **!** CAUTION!

**If the dispensing paddle is pushed for an extended period the dispenser motor may overload and stop. The overload protector will reset automatically after it has cooled down sufficiently.**

- **If a large quantity of ice is needed at one time, it is best to remove cubes directly from the ice cube container**
- **When the ice maker is operating, it is normal to hear the sound of:**
  - the motor running
  - ice dropping into the ice container
  - the water valve opening or closing
  - ice loosening in the tray
  - running water.

## CLEANING THE ICE DISPENSER

Clean the dispenser and ice container at regular intervals, particularly before you take a holiday or move, also clean the dispenser if it sticks.

To clean the dispenser:

1. Remove the ice container by lifting it up and out. Empty and carefully clean the container with mild detergent. Rinse carefully ensuring no traces of detergent remain. Do not use harsh or abrasive cleaners. Allow the ice container to dry completely before replacing it in the freezer. If ice has accumulated on the surface, remove with a warm, damp cloth or allow to defrost. Do not use sharp instruments to remove ice.
2. Remove ice chips from the shelf and chute that support the ice container; clean these areas.
3. Replace the ice container.

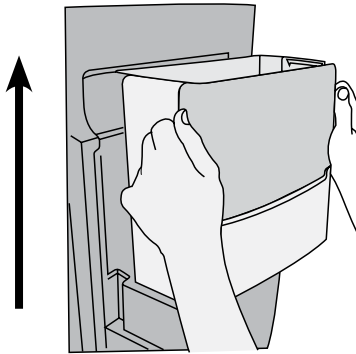

### **! WARNING!**

**Do not put fingers up the ice chute. Surfaces there may be sharp.**

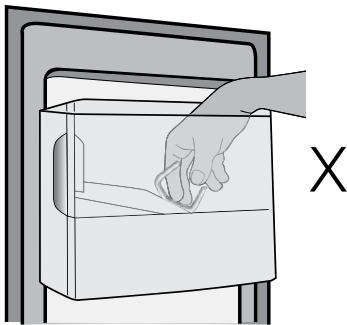

### **! CAUTION!**

**When removing or replacing the ice bin do not rotate the stirrer in the ice bin. If the stirrer is accidentally turned, you may need to realign the stirrer until the ice bin fits into place with the drive mechanism. When refitting the ice bin make sure it is fully seated on the door panel.**

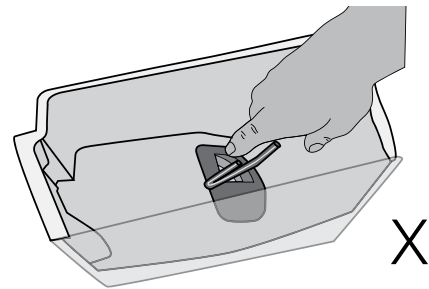
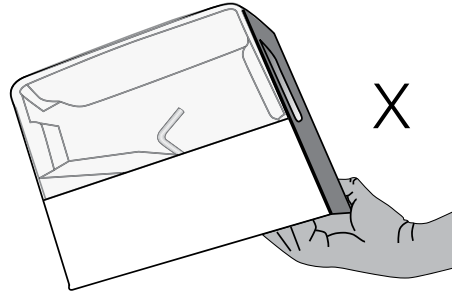

### **Remove and empty the ice storage bin if:**

1. An extended power failure (one hour or longer) causes ice cubes in the ice storage bin to melt and freeze together and jam the dispenser mechanism.
2. If the ice dispenser is not used frequently, ice cubes will freeze together in the bin and jam the dispenser mechanism. If this happens remove the ice storage bin and dispose of the ice.

### **! CAUTION!**

**NEVER use an ice pick or similar sharp instrument to break up the ice. This could damage the ice storage bin and dispenser mechanism.**

## CHANGING THE WATER FILTER

If you purchased a refrigerator with a water filter (ice and water models), please read the following care and use information.

An external water filter and connection kit has been supplied for use with your ice & water refrigerator. The external filter design allows more space within the refrigerator and provides double the life of previous filters reducing the cost of replacement. The filter is designed to significantly reduce chlorine, taste, odour, heavy metals, turbidity (cloudiness) and scale build up. The included plastic water tube allows quick connection to the filter and is designed for high durability and kink resistance.

This filter is designed only to be used with a potable water supply. It should not be used on water that is micro biologically unsafe or with water of unknown quality. The filter should be replaced every 12 months. The service life of the filter may be reduced in water supplies that contain an excess of particles or other impurities. Reduced flow rate is an indication that a new filter is required. Failure to replace the filter when required can affect the function of the ice maker. Service calls caused by a failure to replace the filter are not covered by warranty (see the 'warranty' section).

### To change the filter:

1. Turn off the water supply.
2. Release the pressure in the water lines by holding a container against the water dispenser paddle on the refrigerator until the pressure has been released.
3. Turn off the refrigerator at the power point and remove the plug from the socket.
4. Remove the circlip, depress the collet and pull the tube out of each end of the filter.
5. Extend the red collar and clip a circlip around the collar at each end of the new filter.
6. Refit the tubes into the new filter past the insertion mark. Ensure the flow direction of the filter is observed and the fitment date is written on the body.
7. Turn the water supply back on and check for leaks.
8. Plug the unit back in and turn the power supply to the refrigerator back on.
9. Purge and dispose of approximately 2 litres of water through the water dispenser to condition the filter and clear the water lines of air and impurities. It may take up to a minute to get a full flow of water from the dispenser. Do not be alarmed if there is an initial black colour to the water, this is residual carbon dust from the filter and is non-toxic.
10. Once the lines have been purged dispose of the first few batches of ice to ensure that impurities have been flushed from this part of the system.

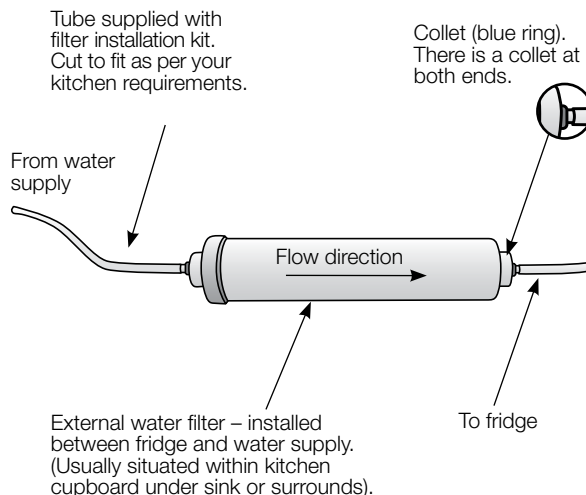

Water conditions vary throughout the world, but changing the water filter every 12 months will ensure the highest possible water quality. The electronics in the refrigerator will determine that the filter has been used for 12 months. After 12 months of use the 'Replacement Water Filter' words and 'Filter icon' will appear and alarm will sound to advise the filter should be replaced.

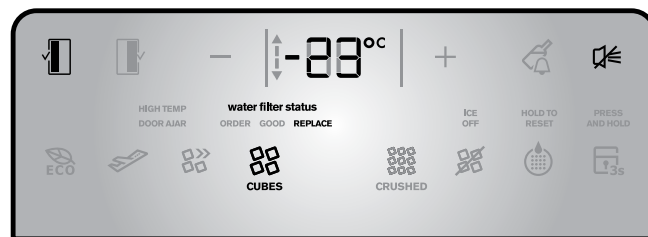

## LED LIGHTING

Your refrigerator is fitted with long life LED lighting. In the unlikely event the LED lights should ever fail, then the LED lights should be serviced by the manufacturer, its service agent or similarly qualified technician. Refer to the warranty page for contact details.

## CLEANING YOUR REFRIGERATOR

### **! WARNING!**

**BEFORE CLEANING:** Turn the refrigerator off at the power point and unplug the cord to prevent any chance of electrocution.

#### **Doors and exterior – stainless steel**

Your stainless steel appliance is manufactured from a mark resistant stainless steel. This stainless steel has a special advanced protective coating that eases the removal of marks such as finger prints and water spots. To keep your stainless steel appliance looking at its best, you should clean it regularly. You should only clean the stainless steel doors with lukewarm soapy water and a soft cloth, rinsing with clean water and then wipe the surface with clean water and a soft clean cloth to remove soap residue.

#### **Doors – surface hardened acrylic**

Clean outside of door with the anti-static cleaner supplied (ACL Staticide #2003). It is designed to reduce dust accumulation on acrylic surfaces. Alternatively, use lukewarm soapy water and a soft cloth, rinsing with clean water and then wipe the surface with a soft clean cloth to remove soap residue.

### **! CAUTION!**

**Do not use abrasive pads or other cleaners as they are likely to scratch the surface. Damage to this product after installation is not covered by your warranty.**

#### **Drip Tray (Ice & Water models only)**

Water may accumulate in the sump located under the drip tray. If this occurs the sump can be sponged out to prevent water overflowing down the front of the door.

For cleaning, remove the tray as described below:

1. Insert a finger in the opening at the rear of the drip tray.
2. Whilst holding the front of tray, lever the back upwards.
3. To refit, position the front of the tray into the front of the sump then lower the back of the tray into position.

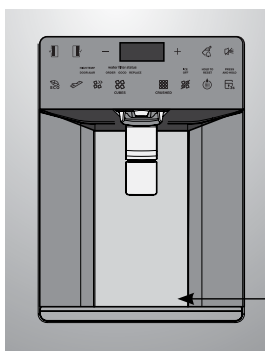

opening in  
drip tray

#### **Cleaning the interior**

You should clean the refrigerator interior regularly. It will be easiest to clean when the food supply is low. Wash the interior with a soft cloth and use an unscented mild soap with lukewarm water. Thoroughly dry all surfaces and removable parts. Avoid getting water on refrigerator controls. If you have taken out any removable parts, replace them and switch the power on before restocking the refrigerator with food. You should keep the interior of your refrigerator hygienic by promptly and thoroughly wiping up any food spills.

#### **Keep door seals clean**

Take care to keep door seals clean. Sticky food and drink can cause seals to stick to the cabinet and tear when you open the door. Wash the seal with a mild detergent and warm water. Rinse thoroughly with clean water and dry.

### **! CAUTION!**

Never use hot water, solvents, commercial kitchen cleaners, aerosol cleaners, metal polishes, caustic or abrasive cleaners, or scourers to clean your refrigerator.

Many commercially available cleaning products and detergents contain solvents that will damage your refrigerator. Use only a soft cloth with an unscented mild soap and lukewarm water.

If your refrigerator has telescopic extension slides, simply wipe them with a damp cloth to clean them and never immerse them in water.

#### **Energy consumption (electricity costs)**

The following guide will help you reduce the running cost of your new refrigerator. This will save you money and help conserve our valuable energy resources.

- If you keep your old refrigerator, save power by switching it off when not in use
- Do not set your freezer temperature too low. After 24 hours, ice cream should be firm but able to be scooped out with a spoon without bending the handle. If ice cream is firmer than this (or too soft), adjust the freezer temperature controls
- Ensure that the refrigerator doors seal properly as you close them
- Before you open the refrigerator doors, decide what you want to put in or take out. This will minimize the time you have the doors open
- It is best to have the refrigerator in a place that is out of direct sunlight and away from heating appliances of any kind. For example, do not place the refrigerator next to a cooker, stove or dishwasher
- Allow hot foods to cool to room temperature before you put them in your freezer
- Thaw frozen food in the refrigerator section



- If you keep the freezer compartment filled to capacity, your food mass will help maintain the freezer temperature when you open the door
- Do not block air vents. Doing so may cause the refrigerator to run longer and use more energy.

**Switching off your refrigerator**

If you switch your refrigerator off for an extended period, follow these steps to reduce the chances of mould:

1. Take all the food out of the refrigerator and freezer compartments.
2. Switch off the refrigerator and remove the electric cord from the power point.
3. Clean the inside.
4. Leave the doors open. This prevents bacteria from growing and causing smells in the refrigerator.

**Power failure**

If there is a power failure in your area, keep the door to the freezer closed. Most foods in your freezer will stay frozen for 24 hours.

**Safety**

It is important to use your appliance safely. This means you need to supervise young children and infirm persons when they use it. You need to make sure that young children do not play with the appliance. Follow the tips below.

<b>always do this</b>
⊙ Check the power point is properly earthed – if you are not sure get an electrician to check it.
⊙ Switch off and unplug the refrigerator at the power point before you clean or move it.
⊙ If the power supply cord is damaged, have it replaced by the manufacturer, service agent or similarly qualified person.
⊙ In the unlikely event the LED lights should ever fail, they should be serviced by the manufacturer, it's service agent or similarly qualified technician.
<b>never do this</b>
⊙ Never let children play with the refrigerator.
⊙ Never store spray cans, explosive fluids or flammable liquids in the refrigerator.
⊙ Never store fizzy drinks in the freezer compartment.
⊙ Never lick icy foods when they first come out of the freezer. This can burn your lips and mouth.
⊙ Never try to repair the refrigerator yourself.



**WARNING!**  
When you dispose of your old refrigerator or freezer remove any doors. Children can suffocate if they get trapped inside.

**HELPFUL HINTS FOR STORING FOOD**

<b>never do this</b>
⊙ Never use electric heaters, dryers or other mechanical devices to defrost the freezer because you can receive an electric shock.
⊙ Never use electrical appliances inside the food storage areas.
⊙ This appliance contains insulation formed with flammable blowing gases and flammable R600a refrigerant. For safety reasons, take care when you dispose of it.
⊙ Do not damage the appliance circuit.
<b>always do this</b>
⊙ Buy the freshest, best quality food and put it in the refrigerator as soon as possible.
⊙ Cover food with plastic wrap or foil to stop it drying out and to help prevent bad smells.
⊙ Rinse and wrap fish and poultry before you put them in the refrigerator.
⊙ Minimise bacteria by removing stuffing from poultry before you put it in the refrigerator.
⊙ When you store eggs in the refrigerator compartment, store them with the pointed end down.
<b>never do this</b>
⊙ Store bananas, avocados or mangoes in the refrigerator. This can cause them to go black or to go soft.
⊙ Put hot or warm food in the refrigerator. Allow it to cool first.

**HELPFUL HINTS FOR FREEZING FOOD**

You can use the freezer to store food which you buy in bulk when prices are low. You can also cook extra food and freeze it for later use.

<b>always do this</b>
⊙ Buy the freshest, best quality food and put it in the freezer as soon as possible.
⊙ Place food in plastic bags or plastic wrap before you put it in the freezer.
⊙ Squeeze the air out of plastic bags as this prevents frost.
⊙ When you buy frozen foods in the supermarket, keep them in their packaging when you store them.
⊙ Defrost food, especially chicken and fish, in the refrigerator compartment. This stops bacteria from growing.
⊙ Leave food in its wrapping while it defrosts.
⊙ Use defrosted food immediately.
<b>never do this</b>
⊙ Never refreeze defrosted food.

## TROUBLESHOOTING

If you think something may be wrong with your refrigerator, you can carry out some easy checks before calling for service. You may locate the problem, sparing yourself any inconvenience and saving time and money.

problem	solution
When your appliance is not operating	<ul style="list-style-type: none"> <li>• Check that the power cord is plugged into the power outlet properly and that the outlet is switched 'ON'</li> <li>• Try running another appliance from the power outlet. If no power is coming from the outlet you may have blown a fuse or tripped a circuit of your household power supply</li> <li>• Try adjusting the temperature control to a slightly 'colder' position</li> <li>• It is normal for the freezer fan NOT to operate during the automatic defrost cycle, or for a short time after the appliance is switched on</li> </ul>
When there is refrigerator/freezer noise	<p>Modern refrigerators/freezers with increased storage capacity use high speed compressors. These can provide a seemingly high level of sound which is quite normal. Normal operational sounds include:</p> <ul style="list-style-type: none"> <li>• Occasional gurgling, similar to water boiling</li> <li>• Air flow noise (air circulates because of a small fan)</li> <li>• A popping noise heard during automatic defrost</li> <li>• A clicking noise heard just before the compressor starts (this is merely the automatic switching action of the temperature control, turning the compressor on or off)</li> </ul> <p>Other strange sounds may mean that you need to check and take action. For example, noises may mean that:</p> <ul style="list-style-type: none"> <li>• The cabinet is not level</li> <li>• The floor is uneven or weak</li> <li>• Bottles are badly placed and rattling</li> <li>• There are vibrations from an object on top of or behind or beside the refrigerator.</li> <li>• The back of the refrigerator cabinet is touching the wall</li> </ul> <p>Remember it is quite normal for noise to seem louder just after the refrigerator starts operating and at night time.</p>
If there are odours inside the appliance	<ul style="list-style-type: none"> <li>• The interior may need cleaning</li> <li>• Some foods produce odours</li> <li>• Some containers and wrapping can cause odours</li> <li>• Ask yourself if the odour started about the same time you started storing something unusual or with a strong smell</li> </ul>
When the motor seems to run more than expected	<p>Your new appliance provides you with large capacities in both the refrigerator section and the separate freezer. It is normal for the motor to operate frequently. However, to keep operation to a minimum, check the following:</p> <ul style="list-style-type: none"> <li>• Are doors kept open too long or too often?</li> <li>• Are controls set too cold? Refer to 'Controlling the temperature'</li> <li>• Have large amounts of warm food just recently been stored? Summer, festive seasons and holidays usually mean a lot more work for your appliance</li> <li>• If the day is hot or the room is very warm, the appliance will need to run more than normal</li> <li>• The appliance will run more than normal just after you install it or when it has been turned off for a long time</li> </ul>

## TROUBLESHOOTING

<b>problem</b>	<b>solution</b>
If the temperature in the refrigerator is too warm	<ul style="list-style-type: none"> <li>• Check that the appliance has enough clearance at the sides, back and top (refer to the installation instructions at the front of this booklet)</li> <li>• Refer to 'Controlling the temperature'</li> <li>• You may have kept the door open too long or too frequently</li> <li>• Food containers or packaging may be holding a door open</li> </ul>
If the temperature in the refrigerator is too cold	<ul style="list-style-type: none"> <li>• Refer to 'Controlling the temperature'</li> <li>• Increase the temperature to avoid high energy consumption</li> </ul>
If heavy frosting occurs in the freezer	<ul style="list-style-type: none"> <li>• Make sure you fully close the freezer and fridge doors. If the doors are left partly open a heavy frost will coat the inside of the freezer. If a frost develops, remove it. Take care to properly close the doors and the frost will not reoccur</li> <li>• Doors should close automatically from 45° open, if not adjust cabinetry (refer to cabinet alignment)</li> </ul>
If water drips on the floor	<ul style="list-style-type: none"> <li>• The defrost water tray, (located at the back or underneath of the cabinet), may not be properly positioned, or the drain tube may not be properly positioned to direct water into this tray. You may need to pull the refrigerator away from the wall to check the tray and tube</li> <li>• A door may have been left open, check that the doors are closed correctly</li> </ul>
Fridge does not exit vacation mode	<ul style="list-style-type: none"> <li>• Turn appliance off at the power point. Leave off for 5 minutes for the memory to clear, then turn back on</li> </ul>
If your electronic display does not respond	<ul style="list-style-type: none"> <li>• If no buttons have been pressed for approximately 60 seconds there may be a delay of up to 2 seconds before the display reacts. This is normal and is to prevent accidental changes to the settings</li> </ul>
Door opens when other is closed	<ul style="list-style-type: none"> <li>• It is normal for a freezer or fridge door to momentarily pop open when the other door is closed, if the cabinet is adjusted properly the door will re-close quickly</li> </ul>

## ICE + WATER TROUBLESHOOTING

Problem	Possible causes	Solution
<b>Automatic ice-maker</b>		
The ice maker is not making any ice	<ul style="list-style-type: none"> <li>Ice maker is in the OFF position</li> <li>Water tap is turned off</li> <li>The freezer is not cold enough</li> <li>The water dispenser may not be dispensing water</li> <li>Filter may be blocked</li> </ul>	<ul style="list-style-type: none"> <li>See Ice maker section in user manual: turn switch to ON position</li> <li>Turn on the water tap</li> <li>See the Problem section: 'If the temperature in the refrigerator is too warm'</li> <li>If it isn't, the ice &amp; water filter cartridge may be clogged or restricted by foreign material, and will need to be replaced</li> <li>Check and/or change filter</li> </ul>
The ice-maker is not making enough ice	<ul style="list-style-type: none"> <li>The ice maker is producing less ice than you expect</li> <li>The freezer is not cold enough</li> <li>Household water tap is not open</li> <li>The water dispenser is dispensing slower than normal</li> </ul>	<ul style="list-style-type: none"> <li>The ice maker should produce approximately 0.5-1 kilogram of ice every 24 hours</li> <li>See section 'Controlling temperatures'</li> <li>Open the household water tap</li> <li>Replace the water filter cartridge</li> </ul>
Ice cubes are too small or too big	<ul style="list-style-type: none"> <li>Restricted water flow to the ice maker</li> <li>Water pressure may be too low</li> <li>Water pressure may be too high</li> <li>Appliance not levelled correctly</li> </ul>	<ul style="list-style-type: none"> <li>Replace the filter cartridge, as the water filter cartridge may be clogged</li> <li>Check water supply hose for kinks</li> <li>Check water pressure meets minimum and maximum requirement (see install instructions)</li> <li>If all of the above is OK adjust ice cube size (refer to 'Adjusting ice cube size' section)</li> </ul>
The ice has a bad odour and taste	<ul style="list-style-type: none"> <li>The ice has picked up odour or flavour from strongly flavoured food stored in the refrigerator or freezer</li> <li>The water running into the ice maker has poor taste or colour</li> <li>Ice not used frequently enough</li> </ul>	<ul style="list-style-type: none"> <li>Cover foods tightly. Discard stale ice. The ice maker will produce a fresh supply</li> <li>Add or replace water filter to water supply. Consult a water purifying company</li> <li>Discard stale ice monthly</li> </ul>
<b>Ice dispenser</b>		
The dispenser will not dispense ice	<ul style="list-style-type: none"> <li>The ice storage container is empty</li> <li>The ice chute is blocked</li> </ul>	<ul style="list-style-type: none"> <li>Refer 'the ice maker is not making any ice' section above</li> <li>The first supply of ice may take up to 4 hours after power up, try the dispenser after ice is made</li> <li>Remove ice bin to gain access to chute underneath and remove any ice causing the blockage. Dry the surface of the chute with a paper towel or similar and replace the ice bin ensuring it is fully seated on the door</li> </ul>
The ice dispenser is jammed	<ul style="list-style-type: none"> <li>Ice has melted and frozen around the stirrer or in the crusher due to infrequent use, temperature fluctuations and/or power outages</li> <li>Ice cubes are hollow or smaller than normal</li> </ul>	<ul style="list-style-type: none"> <li>Remove the ice bin and empty its contents. Use warm water to melt any ice in the bin and crusher. Leave to dry completely so water does not refreeze in the bin causing a further blockage and refit. Make sure the bin is fully seated on the door. When new ice is made the dispenser should operate</li> <li>The water filter cartridge could be clogged. Cartridge may need replacing</li> </ul>
Water leaking from ice dispenser	<ul style="list-style-type: none"> <li>Ice trapped and melting in ice chute</li> <li>Ice cubes too small and falling into ice dispenser</li> </ul>	<ul style="list-style-type: none"> <li>Clear ice chute of ice</li> <li>Check ice cube size (refer to 'Adjusting ice cube size' section)</li> </ul>
The flap on the ice dispenser is not closing properly	<ul style="list-style-type: none"> <li>Ice cubes are preventing the flap from closing properly</li> </ul>	<ul style="list-style-type: none"> <li>Remove ice bin to gain access to the ice chute and remove ice cubes from chute</li> </ul>





**This document sets out the terms and conditions of the product warranties for Electrolux Appliances. It is an important document. Please keep it with your proof of purchase documents in a safe place for future reference should you require service for your Appliance.**

1. In this warranty
  - (a) 'acceptable quality' as referred to in clause 10 of this warranty has the same meaning referred to in the ACL;
  - (b) 'ACL' means Trade Practices Amendment (Australian Consumer Law) Act (No.2) 2010;
  - (c) 'Appliance' means any Electrolux product purchased by you accompanied by this document;
  - (d) 'ASC' means Electrolux' authorised serviced centres;
  - (e) 'Electrolux' means Electrolux Home Products Pty Ltd of 163 O'Riordan Street, Mascot, NSW 2020, ABN 51 004 762 341 in respect of Appliances purchased in Australia and Electrolux (NZ) Limited of 3-5 Niall Burgess Road, Mount Wellington, in respect of Appliances purchased in New Zealand;
  - (f) 'major failure' as referred to in clause 10 of this warranty has the same meaning referred to in the ACL and includes a situation when an Appliance cannot be repaired or it is uneconomic for Electrolux, at its discretion, to repair an Appliance during the Warranty Period;
  - (g) 'Warranty Period' means:
    - (i) where the Appliance is used for personal, domestic or household use (i.e. normal single family use) as set out in the instruction manual, the Appliance is warranted against manufacturing defects in Australia and New Zealand for 24 months and for the Appliance's compressor, condenser, evaporator and drier, an additional 36 months parts only warranty applies, following the date of original purchase of the Appliance;
    - (ii) where the Appliance is used for commercial purposes (including being used to directly assist a business or where the Appliance is used in a multi-family communal or share type environment), the Appliance will then be warranted against manufacturing defects in Australia for 3 months and in New Zealand for 3 months, following the date of original purchase of the Appliance.
  - (h) 'you' means the purchaser of the Appliance not having purchased the Appliance for re-sale, and 'your' has a corresponding meaning.
2. This warranty only applies to Appliances purchased and used in Australia or New Zealand and is in addition to (and does not exclude, restrict, or modify in any way) any non-excludable statutory warranties in Australia or New Zealand.
3. During the Warranty Period Electrolux or its ASC will, at no extra charge if your Appliance is readily accessible for service, without special equipment and subject to these terms and conditions, repair or replace any parts which it considers to be defective. Electrolux or its ASC may use remanufactured parts to repair your Appliance. You agree that any replaced Appliances or parts become the property of Electrolux. This warranty does not apply to light globes, batteries, filters or similar perishable parts.
4. Parts and Appliances not supplied by Electrolux are not covered by this warranty.
5. You will bear the cost of transportation, travel and delivery of the Appliance to and from Electrolux or its ASC. If you reside outside of the service area, you will bear the cost of:
  - (a) travel of an authorised representative;
  - (b) transportation and delivery of the Appliance to and from Electrolux or its ASC,

In all instances, unless the Appliance is transported by Electrolux or an
- Electrolux authorised representative, the Appliance is transported at the owner's cost and risk while in transit to and from Electrolux or its ASC.
6. Proof of purchase is required before you can make a claim under this warranty.
7. You may not make a claim under this warranty unless the defect claimed is due to faulty or defective parts or workmanship. Electrolux is not liable in the following situations (which are not exhaustive):
  - (a) the Appliance is damaged by:
    - (i) accident
    - (ii) misuse or abuse, including failure to properly maintain or service
    - (iii) normal wear and tear
    - (iv) power surges, electrical storm damage or incorrect power supply
    - (v) incomplete or improper installation
    - (vi) incorrect, improper or inappropriate operation
    - (vii) insect or vermin infestation
    - (viii) failure to comply with any additional instructions supplied with the Appliance;
  - (b) the Appliance is modified without authority from Electrolux in writing;
  - (c) the Appliance's serial number or warranty seal has been removed or defaced;
  - (d) the Appliance was serviced or repaired by anyone other than Electrolux, an authorised repairer or ASC.
8. This warranty, the contract to which it relates and the relationship between you and Electrolux are governed by the law applicable where the Appliance was purchased. Where the Appliance was purchased in New Zealand for business purposes the Consumer Guarantee Act does not apply.
9. To the extent permitted by law, Electrolux excludes all warranties and liabilities (other than as contained in this document) including liability for any loss or damage whether direct or indirect arising from your purchase, use or non use of the Appliance.
10. For Appliances and services provided by Electrolux in Australia, the Appliances come with a guarantee by Electrolux that cannot be excluded under the Australian Consumer Law. You are entitled to a replacement or refund for a major failure and for compensation for any other reasonably foreseeable loss or damage. You are also entitled to have the Appliance repaired or replaced if the Appliance fails to be of acceptable quality and the failure does not amount to a major failure. The benefits to you given by this warranty are in addition to your other rights and remedies under a law in relation to the Appliances or services to which the warranty relates.
11. At all times during the Warranty Period, Electrolux shall, at its discretion, determine whether repair, replacement or refund will apply if an Appliance has a valid warranty claim applicable to it.
12. For Appliances and services provided by Electrolux in New Zealand, the Appliances come with a guarantee by Electrolux pursuant to the provisions of the Consumer Guarantees Act, the Sale of Goods Act and the Fair Trading Act.
13. To enquire about claiming under this warranty, please follow these steps:
  - (a) carefully check the operating instructions, user manual and the terms of this warranty;
  - (b) have the model and serial number of the Appliance available;
  - (c) have the proof of purchase (eg an invoice) available;
  - (d) telephone the numbers shown below.
14. You accept that if you make a warranty claim, Electrolux and its ASC may exchange information in relation to you to enable Electrolux to meet its obligations under this warranty.

### Important Notice

Before calling for service, please ensure that the steps listed in point 13 above have been followed.

<p><b>FOR SERVICE</b> or to find the address of your nearest state service centre in Australia <b>PLEASE CALL 13 13 49</b> For the cost of a local call (Australia only)</p>	<p><b>SERVICE AUSTRALIA</b>  ELECTROLUX HOME PRODUCTS www.electrolux.com.au</p>	<p><b>FOR SPARE PARTS</b> or to find the address of your nearest state spare parts centre in Australia <b>PLEASE CALL 13 13 50</b> For the cost of a local call (Australia only)</p>
<p><b>FOR SERVICE</b> or to find the address of your nearest authorised service centre in New Zealand <b>FREE CALL 0800 10 66 10</b> (New Zealand only)</p>	<p><b>SERVICE NEW ZEALAND</b>  ELECTROLUX HOME PRODUCTS www.electrolux.co.nz</p>	<p><b>FOR SPARE PARTS</b> or to find the address of your nearest state spare parts centre in New Zealand <b>FREE CALL 0800 10 66 20</b> (New Zealand only)</p>



## Electrolux Home Products Australia

telephone: 1300 363 640  
fax: 1800 350 067  
email: [customercare@electrolux.com.au](mailto:customercare@electrolux.com.au)  
web: [www.electrolux.com.au](http://www.electrolux.com.au)

## Electrolux Home Products New Zealand

telephone: 09 573 2384  
fax: 09 573 2221  
email: [customercare@electrolux.co.nz](mailto:customercare@electrolux.co.nz)  
web: [www.electrolux.co.nz](http://www.electrolux.co.nz)

### The Thoughtful Design Innovator.

Do you remember the last time you opened a gift that made you say "Oh! How did you know? That's exactly what I wanted!" That's the kind of feeling that the designers at Electrolux seek to evoke in everyone who chooses or uses one of our products. We devote time, knowledge, and a great deal of thought to anticipating and creating the kind of appliances that our customers really need and want.

This kind of thoughtful care means innovating with insight. Not design for design's sake, but design for the user's sake. For us, thoughtful design means making appliances easier to use and tasks more enjoyable to perform, freeing our customers to experience that ultimate 21st century luxury, ease of mind. Our aim is to make this ease of mind more available to more people in more parts of their everyday lives, all over the world. So when we say we're thinking of you, you know we mean just that.

The "Thinking of you" promise from Electrolux goes beyond meeting the needs of today's consumers. It also means we're committed to making appliances safe for the environment—now and for future generations.

### Electrolux. Thinking of you.

Share more of our thinking at [www.electrolux.com.au](http://www.electrolux.com.au) or [www.electrolux.co.nz](http://www.electrolux.co.nz)



**P/No. 1461409**

© 2013 Electrolux Home Products Pty Ltd  
ABN 51 004 762 341

EMAN\_SxSFri\_Mar13