

# dimensions and installation guide

## electrolux e:line induction cooktop

model **EHD80170P**

### product and cut-out dimensions

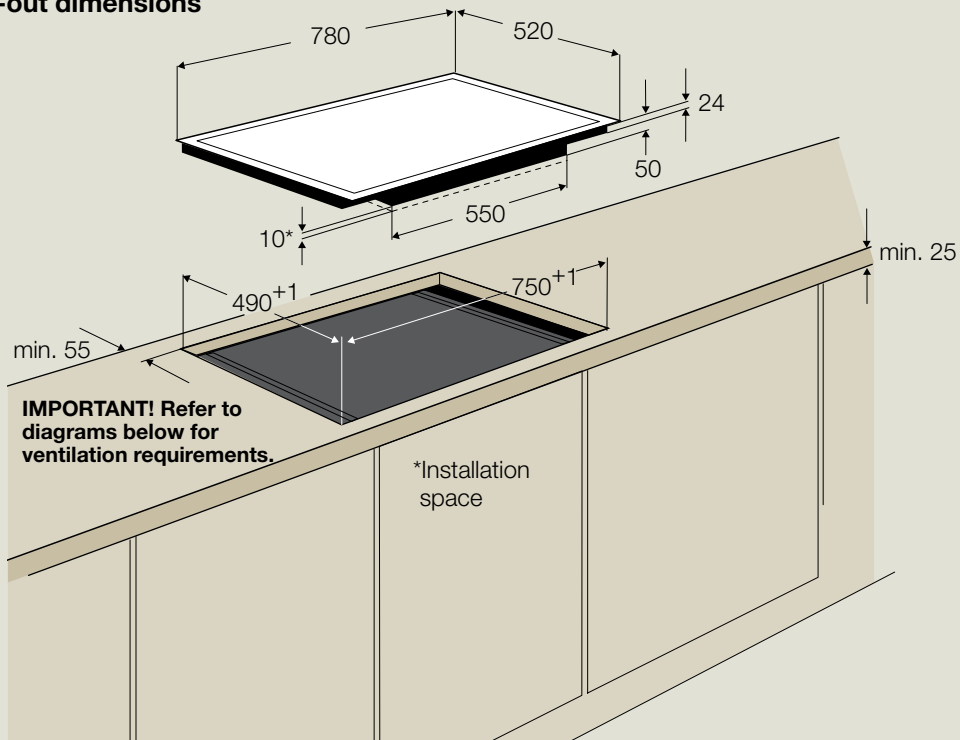

### ventilation and benchtop requirements

**Important:** The ventilation gap of 5mm under the bench top as pictured must be observed in order to prevent overheating of the induction cooktop, which can result in damage to the appliance.

**WARNING!** Surface temperature of base exceed 95°C, under bench access must be restricted by use of non-combustible barrier or installation.

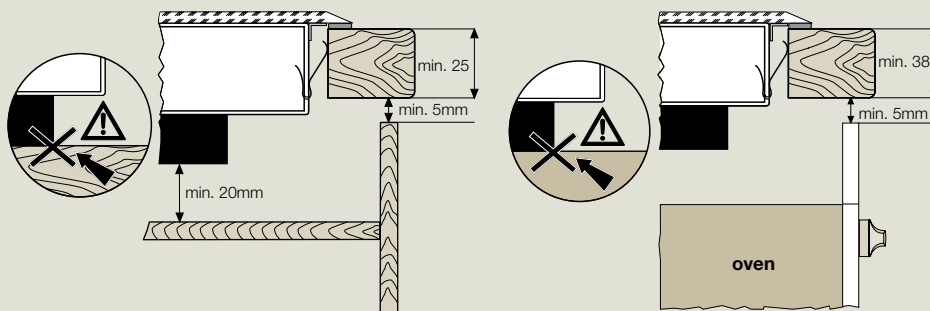

**WARNING:** Under no circumstances should the cooktop base be installed directly onto a shelf.

### IMPORTANT

This is a guide of product dimensions only. For complete installation instructions, refer to the manual provided with product.

All measurements in millimetres  
Current as at November 2009  
© 2009 Electrolux Home Products Pty Ltd. EIGEHD80170P 11/09

*Thinking of you*  
**Electrolux**