

WASHING MACHINE

INSTRUCTION BOOKLET

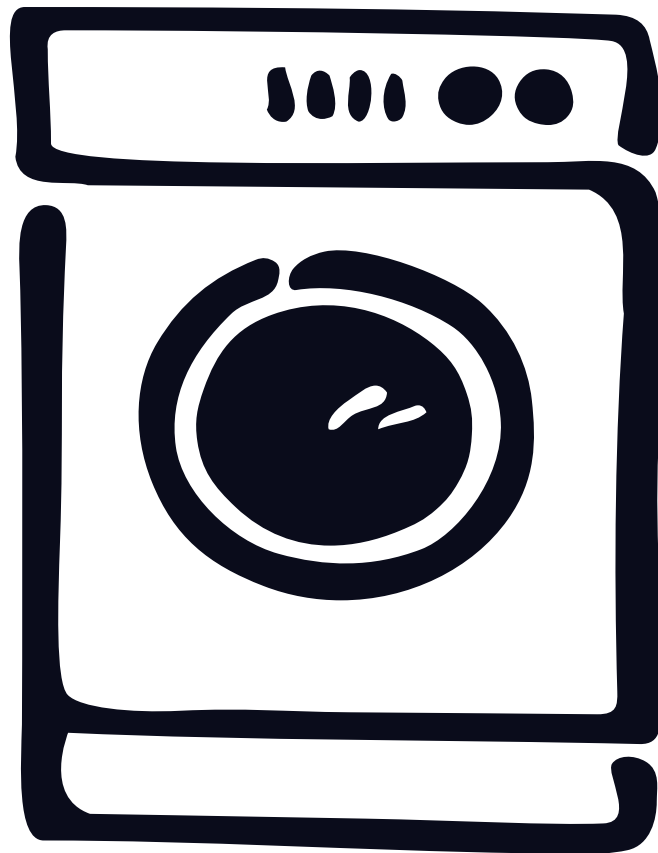

EWF1087

Contents

Warnings	3	Operating sequence	14-16
Disposal	4	Washing programmes	17
		International wash code symbols	18
Tips for environmental protection	4	Maintenance	19
Technical specifications	4	After each wash	19
Installation	5	Maintenance wash	19
Unpacking	5	Door seal	19
Positioning	5	Cabinet	19
Water inlet	5	Detergent dispenser drawer	19
Water drainage	6	Drain pump	20
Electrical connection	6	Water inlet filter	20
		Emergency emptying out	20
		The dangers of freezing	21
Your new washing machine	7	Trouble-Shooting Guide	22-23
Detergent dispenser drawer	7	Electrolux Warranty	
Use	8	New Zealand and Australia	24
Control panel	8		
Controls	8-11		
Washing hints	12		
Sorting the laundry	12		
Temperatures	12		
Before loading the laundry	12		
Maximum loads	12		
Laundry weights	12		
Removing stains	12		
Detergents and additives	13		

The symbols you will see on some paragraphs of this booklet have the following meaning:



The warning triangle and/or the key words (Warning!, Caution!) emphasize information that is particularly important for your safety or correct functioning of the appliance.



The information marked with this symbol provides additional instructions and practical tips on the use of the appliance.



Tips and information about economical and ecological use of the machine are marked with this symbol.

Our contribution to the protection of the environment: we use environmentally friendly paper.

Dear customer,

Please read these operating instructions carefully and pay particular attention to the safety notes indicated below. We recommend that you keep this instruction manual for future reference and pass it on to any future owners.

Warnings

The following warnings are provided in the interests of overall safety. You must read them carefully before installing or using the appliance.

Installation

- When unpacking the appliance, check that it is not damaged. If in doubt, do not use it and contact the Service Centre.
- All internal packing must be removed before using the appliance. Serious damage may be caused to the machine or adjacent furniture if the protective transit devices are not removed or are not completely removed. Refer to the relevant paragraph in the instruction book.
- Any electrical work required to install this appliance must be carried out by a qualified electrician.
- Any plumbing work required to install this appliance must be carried out by a qualified plumber.
- After having installed the machine, check that it is not standing on its electrical supply cable.
- If the appliance is placed on a carpeted floor, ensure that air can circulate freely between the feet and the floor.
- The appliance incorporates backflow protection complying with AS/NZS 3500.1.2. No further backflow protection required for connection to the water supply.

Use

- This appliance is designed for domestic use. It must not be used for purposes other than those for which it was designed.
- Only wash fabrics which are designed to be machine washed. Follow the instructions on each garment label.
- Do not overload the appliance. Follow the instructions in the instruction book.
- Make sure that all pockets are empty. Objects such as coins, safety pins, pins and screws can cause extensive damage.
- Do not machine wash garments saturated with petroleum, methylated spirits, trichlorethylene, etc. If such fluids have been used to remove stains prior to washing, wait until they have completely evaporated from the fabric before placing garments in the appliance.

- Place small items such as socks, belts, etc. in a cloth bag or pillowcase to prevent them getting trapped between the drum and the tub.
- Use only the recommended quantities of fabric softener. An excessive amount could damage the laundry.
- Leave the porthole door slightly ajar when the appliance is not in use. This preserves the door seal and prevents the formation of musty smells.
- Always check that water has emptied out before opening the door. If not, drain the water following the instructions in the instruction book.
- Always unplug the appliance and turn the water tap off after use.

General safety

- Repairs to the machine must be carried out only by qualified personnel. Repairs carried out by inexperienced persons could cause serious danger. Contact your local Service Centre.
- Never pull the power supply cable to remove the plug from the socket; always take hold of the plug itself.
- During high temperature wash programmes the door glass may get hot. Do not touch it!

Child safety

- This washing machine is not intended for use by young children or infirm persons without supervision.
- Young children should be supervised to ensure that they do not play with the appliance.
- The packaging components (e.g. plastic film, polystyrene) can be dangerous to children - danger of suffocation! Keep them out of children's reach.
- Keep all detergents in a safe place out of children's reach.
- When the appliance is to be scrapped, cut off the electrical supply cable and destroy the plug with the remaining cable. Disable the door catch in order to prevent children from becoming trapped inside while playing.

- Make sure that children or pets do not climb into the drum. To avoid this the machine incorporates a special feature. To activate this device, rotate the button (without pressing it) inside the door clockwise until the groove is horizontal. If necessary use a coin.

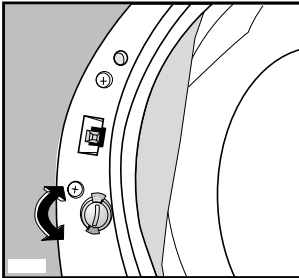

To disable this device and restore the possibility of closing the door, rotate the button anti-clockwise until the groove is vertical.



Disposal

Packaging materials

The materials marked with the symbol  are recyclable.

>PE<=polyethylene

>PS<=polystyrene

>PP<=polypropylene

This means that they can be recycled by disposing of them properly in appropriate collection containers.

Machine

Use authorised disposal sites for your old appliance. Help to keep your country tidy!



Tips for environmental protection

To save water, energy and to help protect the environment, we recommend that you follow these tips:

- Normally soiled laundry may be washed without prewashing or stain in order to save detergent, water and time (the environment is protected too!).
- The machine works more economically if it is fully loaded.

- With adequate pre-treatment, stains and limited soiling can be removed; the laundry can then be washed at a lower temperature.
- Measure out detergent according to the water hardness, the degree of soiling and the quantity of laundry being washed.

Technical specifications

DIMENSIONS	Height	85 cm
	Width	60 cm
	Depth	63 cm
MAXIMUM LOAD	Cotton	7 kg
	Synthetics	3 kg
	Delicates	3 kg
	Woollens and handwash	2 kg
MAX. SPIN SPEED		1000 rpm
POWER SUPPLY VOLTAGE		220-240 V
FREQUENCY		50 Hz
TOTAL POWER ABSORBED		2200 W
MINIMUM FUSE PROTECTION		10 A
WATER PRESSURE	Minimum	50 kPa
	Maximum	800 kPa

Installation

Unpacking

 All transit bolts and packing must be removed before using the appliance.

You are advised to keep all transit devices so that they can be refitted if the machine ever has to be transported again.

1. Using a spanner, unscrew and remove the two rear bottom screws. Slide out the two plastic pins. Lay the machine on its back, taking care not to squash the hoses. This can be avoided by placing one of the corner packing pieces between the machine and the floor.

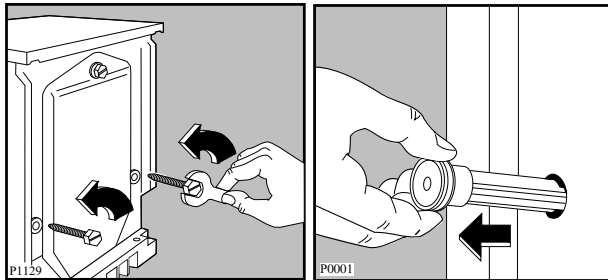

2. Remove the polystyrene block(s) from the bottom of the machine and release the two plastic bags.
3. Very carefully slide out the left polythene bag, removing it towards the right and then downwards.

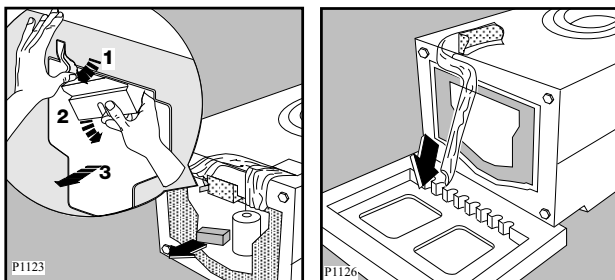

4. Very carefully slide out the right polythene bag, removing it towards the left and then upwards.

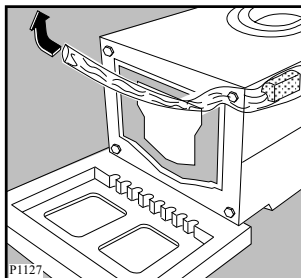

5. Set the machine upright and remove the remaining rear screw. Slide out the relevant pin.
6. Plug all the holes with the plugs which you will find in the envelope containing the instruction manual.

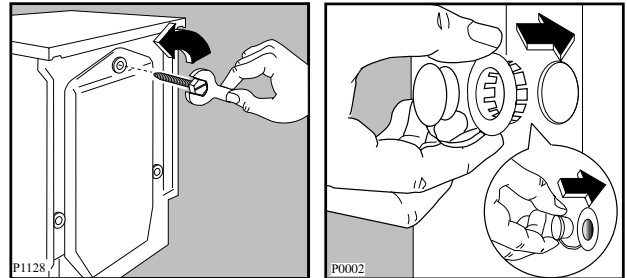

Positioning

Install the machine on a flat hard floor. Make sure that air circulation around the machine is not impeded by carpets, rugs etc. Check that the machine does not touch the wall or cupboard units. Carefully level by screwing the adjustable feet in or out. Never place cardboard, wood or similar materials under the machine to compensate for any unevenness in the floor.

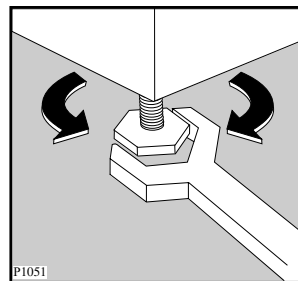

Water inlet

Connect the water inlet hose to a tap with 3/4" BSP thread.

Use the hose supplied with the washing machine. **DO NOT USE OLD HOSES.**

The other end of the inlet hose which connects to the machine can be turned in any direction. Simply loosen the fitting, rotate the hose and retighten the fitting, making sure there are no water leaks.

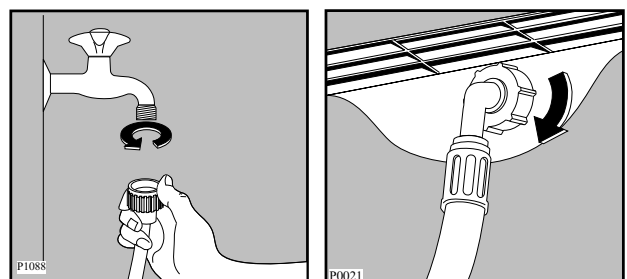

The inlet hose must not be lengthened. If it is too short and you do not wish to move the tap, you will have to purchase a new, longer hose specially designed for this type of use.

Important!

Before connecting up the machine to new pipework or to pipework that has not been used for some time, run off a reasonable amount of water to flush out any debris that may have collected in the pipes.

Water drainage

The end of the drain hose can be positioned in four ways:

Hooked over the edge of a sink using the plastic hose guide supplied with the machine. In this case, make sure the end cannot come unhooked when the machine is emptying.

This could be done by tying it to the tap with a piece of string or attaching it to the wall.

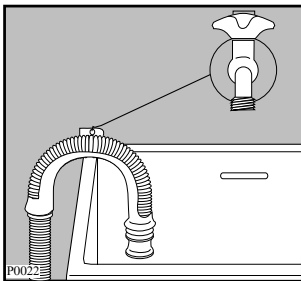

In a sink drain pipe branch. This branch must be above the tap so that the bend is at least 60 cm above the ground.

Directly into a drain pipe at a height of not less than 60 cm and not more than 90 cm.

The end of the drain hose must always be **ventilated**, i.e. the inside diameter of the drain pipe must be larger than the outside diameter of the drain hose.

Floor drain: the washing machine should be installed where a floor drain or hole is located (depending on plumbing regulations). A floor drain is required to drain away water which may overflow from the washing machine due to a hose leak or malfunction.

The drain hose must not be kinked.

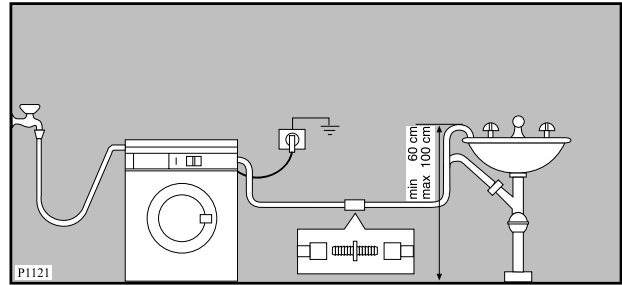

The drain hose may be extended to a maximum of 4 metres. An additional drain hose and joining piece is available from your local Service Centre.

For a correct functioning of the machine the drain hose must remain hooked on the proper support piece situated on the top part of the back side of the appliance.

Electrical connection

Plug the washing machine into a properly earthed 3 pin power point.

DO NOT USE AN EXTENSION CORD.

CAUTION !

If the appliance is supplied from a cord extension set or an electrical portable outlet device, the cord extension set or electrical portable outlet device must be positioned so that it is not subject to splashing or ingress of moisture.



The manufacturer declines any responsibility for damage or injury through failure to comply with the above safety precaution.

IMPORTANT!

If the electrical cord of this appliance is damaged, it must be replaced by the Manufacturer, Authorised Service Agent or similarly qualified person in order to avoid a hazard.

Your new washing machine

This new washing machine meets all modern needs for effective treatment of laundry with low water, energy and detergent consumption.

- **The possibility** of selecting the temperature and all the options offered by this washing machine gives you truly “customised” washing.
- **The DELAY START** option allows you to delay starting of the wash programme to any time of day, so allowing you for instance to make use of overnight economy electricity tariffs.
- **The special wool programme** with its new delicate wash system treats your woollens with extreme care.
- **The balance control device** ensures the machine is stable during the spin.
- **The ECO valve** allows total use of detergent and reduces water consumption so saving energy.

- 1 Detergent dispenser drawer
- 2 Control panel
- 3 Door opening handle
- 4 Drain pump
- 5 Adjustable feet
- 6 Door light indicator

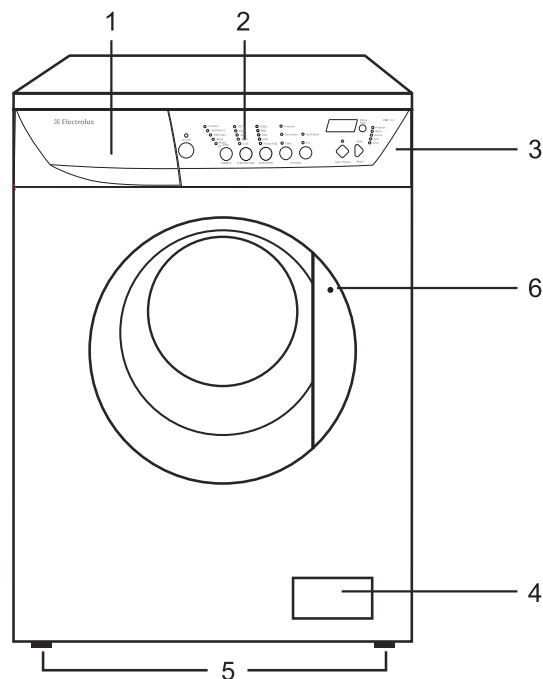

Detergent dispenser drawer

The detergent dispenser is divided into three compartments (fig.). The table of Washing Programmes shows which compartment to use.

Compartment : this compartment is only used for washing powder when a programme has Prewash or Stain.

Compartment : this compartment is used for washing powder on all programmes.

Compartment : this compartment is used for fabric conditioner and starching agent.

Always add laundry detergents before switching the machine on and keep the dispenser clean and dry, so that the detergent can be efficiently dispensed from the unit.

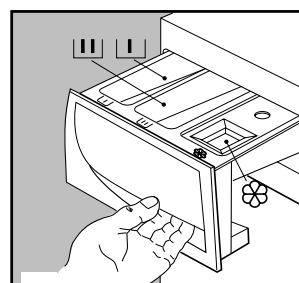

Use

Control panel

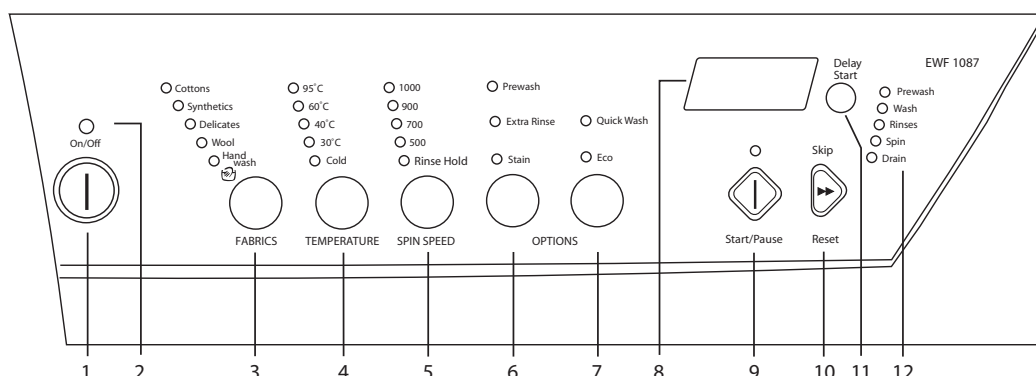

1 ON/OFF button ①

Press this button to switch the washing machine on. Press the ON/OFF button again to switch the machine off.

2 MAINS-ON light

This light is connected to the ON/OFF button. It lights up when you press the button, and goes out when you press it again.

3 FABRICS button

Press this button repeatedly to select the programme on the basis of the type of laundry to be washed. The light relevant to the selected programme will light up. The washing machine will propose a temperature and automatically select the maximum spin value provided for the programme you have chosen. You can change these values by operating buttons 4 and 5.

On the display will appear the duration of the washing programme, depending on the maximum load capacity for each type of fabric, and the START/PAUSE light begins to flash.

Hand wash

When you select this programme, you obtain a particularly delicate washing, suitable for articles of clothing whose label indicates that they must be hand-washed .

4 TEMPERATURE button

Press this button repeatedly to increase or decrease the temperature, if you want your laundry to be washed at a temperature different from the one proposed by the washing machine. The relevant light will light up. Maximum temperatures are 95°C for cotton, 60°C for synthetic fabrics, 40°C for delicate

fabrics, wool and fabrics to be hand-washed (HAND WASH programme).

By selecting position **COLD** the machine will wash with cold water. To be used for extremely delicate items, such as curtains.

5 SPIN SPEED button

Press this button repeatedly to change the spin speed, if you want your laundry to be spun at a speed different from the one proposed by the washing machine. The relevant light will light up.

Maximum speeds are:

- for cotton: 1.000 rpm;
- for synthetic fabrics, wool, and fabrics to be handwashed: 900 rpm;
- for delicate fabrics: 700 rpm.

RINSE HOLD position : when you choose this option, the machine will not drain the water of the last rinse, so as not to wrinkle the laundry.

At the end of the cycle, the light of the START/PAUSE button  goes out, the door is locked, and the RINSE HOLD light remains lit, to indicate that the water must be drained.

To complete the cycle, first press the SKIP RESET button (3 dashes appear on the display), and then choose one of the following options:

- **drain only:**
 - press the FABRICS button to choose any type of fabric, press the SKIP RESET button **3 times**, so as to cause the light DRAIN to light up, and then press the START/PAUSE button.
- **drain and spin:**
 - press the FABRICS button to select the type of fabric previously washed, eventually reduce the spin speed, and then press the SKIP RESET button **twice**, so as to cause the light SPIN to light up, and at the end press the START/PAUSE button.

6-7 OPTIONS buttons

Press this button to select the following options:

- **PREWASH:** select this option if you wish your laundry to be prewashed before the main wash (**not available for WOOL and HAND WASH programme**).
The prewash ends with a short spin in programmes for cotton and synthetic fabrics, whereas in the programme for delicate fabrics the water is only drained.
The **Prewash**, the **EXTRA RINSE** and the **Stain** functions cannot be selected together.
- **EXTRA RINSE:** can be used with all programmes **except the WOOL and HAND WASH programme**. The machine performs 5 rinses instead of 3.
This option is recommended for people who are allergic to detergents and in areas where the water is very soft.
- **STAIN:** select this button if you wish to add to the washing of heavy soiled laundry a stain phase: at the temperature of 40°C the special detergent for stains is loaded from the compartment marked **U**.
This function is available in cotton and synthetic programmes with a temperature of 40° or higher).
The washing time will be prolonged by few minutes.
- **QUICK WASH;** select this function for laundry that is only slightly soiled (**not for WOOL and HAND WASH programme**).
The washing time will be reduced according to the type of fabric and the selected temperature.
- **ECO:** this option is available only with cotton programme at 95°-60°-40° C and synthetics programme at 60°-40° C.

If you select this option the temperature automatically decreases and, consequently, the washing time increases.

This function can be used with normally soiled laundry in order to save energy.

8 Display

The following pieces of information are shown on the display:

- **Three blinking dashes**, when a programme is cancelled by means of the SKIP RESET button.

The three blinking dashes will also appear when you press the ON/OFF button to switch the machine on, if the previously selected cycle has been erased.

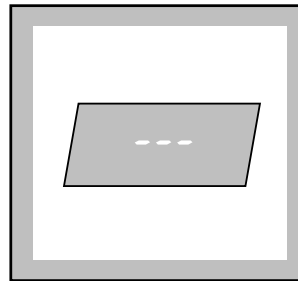

- **Duration of washing programme** in hours and minutes, after you have selected a programme.



While the programme is running (after you have pressed the START/PAUSE button), the displayed time value decreases by one unit every minute.

- **The washing machine has stopped with water in tub**, at the end of a programme with **RINSE HOLD option**: this is indicated by a **blinking zero**.
- **The washing machine has completed the programme**: this is indicated by a **blinking zero**.
The zero will reappear when you switch the washing machine on, unless the previous programme has been erased by means of the SKIP RESET button.

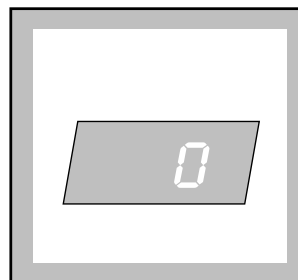

Important!

The first time you use the washing machine, when you switch it on, it may display a blinking zero. This is due to the fact that the washing machine has performed a washing cycle during the manufacturer's inspection tests, and this cycle has not been erased after its completion.

- **Delay start**, a time value indicated in hours and selected by means of the relevant button.

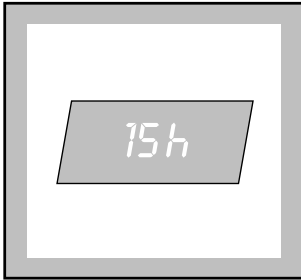

The delay time is displayed for 3 seconds, then the duration of the selected programme reappears. After you have pressed the START/PAUSE button, the countdown begins, and the delay time value decreases by one unit every hour till the first 2 hours, and then it decreases by one unit every 30 minutes.

You can delay the start of every programme selecting the DELAY START button. The delay time is indicated first by 30-60-90 minutes, and then by hours up to 23 hours.

- **An incorrect option selection has been made:** this is indicated by the message **Err** when a function incompatible with the current programme is selected.

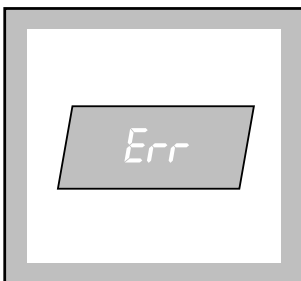

- An alarm code indicates a fault in the machine operation (see the relevant chapter on page 22).

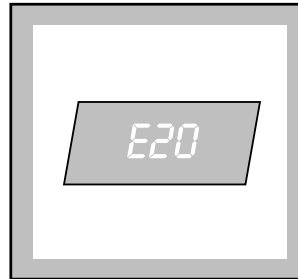

9 START/PAUSE button ◊

This button has two functions:

- **Start:** after you have selected the desired programme and options, press this button to start the washing machine. The light above the button will stop flashing and remain lit.

If you have selected a delay time by means of the relevant button, the countdown will begin and will be shown on the display.

- **Pause:** when you press this button again, the programme in progress is interrupted. The light above the button will start flashing. To restart the programme, press the button again.

Important! You must set the washing machine to PAUSE before you make any change in the programme in progress.

10 SKIP RESET button ➡➡

At the end of a programme, you must press this button once or repeatedly, in order to clear the contents of the memory (the display will show three blinking dashes); otherwise, the next time you switch the washing machine on, the blinking zero will reappear.

You can also press the SKIP RESET button to exclude one or several phases of the programme which is running, as indicated below.

- set the washing machine to PAUSE by pressing the START/PAUSE button (the relevant light will flash);
- press the SKIP RESET button once or several times, until the required phase(s) is(are) cancelled

Example:

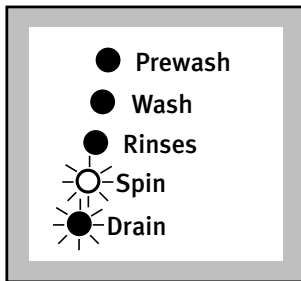

In this case, both the drain and the spin (at the speed provided for the selected type of fabric) will be performed.

This button allows you also to select special programmes, such as **RINSES**, **SPIN** and **DRAIN**.

• **If the machine is already switched on** because it has just performed a washing programme, proceed as follows:

- depress SKIP RESET once or repeatedly to cancel the previously performed programme (three blinking dashes will appear on the display);
- select the type of fabric by means of the relevant button;
- select the special programme:

• RINSES

Depress SKIP RESET **once**, the pilot light WASH goes out.

• SPIN

Depress SKIP RESET **twice**, the pilot lights WASH and RINSES go out.

• DRAIN

Depress SKIP RESET **three times**, the pilot lights WASH, RINSES and SPIN go out and only the pilot light DRAIN remains lit.

Example:

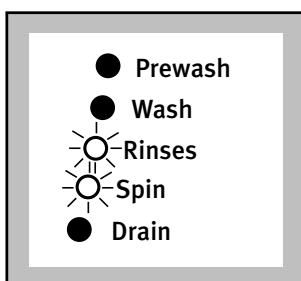

In this case the machine will perform the rinses and spin.

• **If the machine is switched off:**

- depress ON/OFF button to switch it on;
- select the type of fabric by means of the relevant button;
- select the special programme as previously described.

11 DELAY START button

This button makes it possible to delay the starting of the programme by up to 23 hours. The delay you have selected is shown on the display for about 3 seconds; afterwards, the duration of the programme reappears.

You must select this option **after** you have set the programme and **before** you press the START/PAUSE button.

The time value shown on the display will decrease by one unit every hour till the first 2 hours, and then it decreases by one unit every 30 minutes.

You can change the delay time at any moment, before you press the START/PAUSE button.

If you have already pressed the START/PAUSE button, and you wish **cancel** the delay time, proceed as follows:

- set the washing machine to PAUSE by pressing the START/PAUSE button;
- press the DELAY START button **twice**, to erase the delay time. The display will indicate "0".
- press the START/PAUSE button again.

Important!

The door will be locked throughout the delay time.

If you need to open the door, you must first set the washing machine to PAUSE by pressing the START/PAUSE button. After you have closed the door, press the START/PAUSE button again.

12 Programme phase indicator lights

When you select a programme, the lights relevant to the phases that form the programme light up.

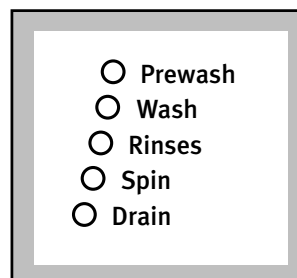

After you have started the programme, only the light relevant to the phase that is currently being carried out will remain lit.

i Washing hints

Sorting the laundry

Follow the wash code symbols on each garment label and the manufacturer's washing instructions. Sort the laundry as follows: whites, coloureds, synthetics, delicates, woollens.

Temperatures

90°-95° for normally soiled white cottons and linen (e.g. tea cloths, towels, tablecloths, sheets...)

60° for normally soiled, colour fast garments (e.g. shirts, night dresses, pyjamas....) in linen, cotton or synthetic fibres and for lightly soiled white cotton (e.g. underwear).

Cold 30°-40° for delicate items (e.g. net curtains), mixed laundry including synthetic fibres and woollens.

The wool wash cycle of this machine has been approved by Woolmark for the washing of machine washable Woolmark products provided that the garments are washed according to the instructions on the garment label and those issued by the manufacturer of this washing machine. Licence No. M9604.

Before loading the laundry

Never wash whites and coloureds together. Whites may lose their "whiteness" in the wash.

New coloured items may run in the first wash; they should therefore be washed separately the first time.

Make sure that no metal objects are left in the laundry (e.g. hair clips, safety pins, pins).

Button up pillowcases, close zip fasteners, hooks and poppers. Tie any belts or long tapes.

Remove persistent stains before washing. Rub particularly soiled areas with a special detergent or detergent paste.

Treat curtains with special care. Remove hooks or tie them up in a bag or net.

General rules:

Cotton, linen: drum full but not too tightly packed;

Synthetics: drum no more than half full;

Delicate fabrics and woollens: drum no more than one third full.

Washing a maximum load makes the most efficient use of water and energy.

For heavily soiled laundry, reduce the load size.

Laundry weights

The following weights are indicative:

bathrobe	1200 g
napkin	100 g
quilt cover	700 g
sheet	500 g
pillow case	200 g
tablecloth	250 g
towelling towel	200 g
tea cloth	100 g
night dress	200 g
ladies' briefs	100 g
man's work shirt	600 g
man's shirt	200 g
man's pyjamas	500 g
blouse	100 g
men's underpants	100 g

Removing stains

Stubborn stains may not be removed by just water and detergent. It is therefore advisable to treat them prior to washing.

Blood: treat fresh stains with cold water. For dried stains, soak overnight in water with a special detergent then rub in the soap and water.

Oil based paint: moisten with benzine stain remover, lay the garment on a soft cloth and dab the stain; treat several times.

Dried grease stains: moisten with turpentine, lay the garment on a soft surface and dab the stain with the fingertips and a cotton cloth.

Rust: oxalic acid dissolved in hot water or a rust removing product used cold. Be careful with rust stains which are not recent since the cellulose structure will already have been damaged and the fabric tends to hole.

Mould stains: treat with bleach, rinse well (whites and fast coloureds only).

Grass: soap lightly and treat with bleach (whites and fast coloureds only).

Ball point pen and glue: moisten with acetone (*), lay the garment on a soft cloth and dab the stain.

Lipstick: moisten with acetone as above, then treat stains with methylated spirits. Remove any residual marks from white fabrics with bleach.

Red wine: soak in water and detergent, rinse and treat with acetic or citric acid, then rinse. Treat any residual marks with bleach.

Ink: depending on the type of ink, moisten the fabric first with acetone (*), then with acetic acid; treat any residual marks on white fabrics with bleach and then rinse thoroughly.

Tar stains: first treat with stain remover, methylated spirits or benzine, then rub with detergent paste.

Do not machine wash garments saturated with petroleum, methylated spirits, trichlorethylene, etc. If such fluids have been used to remove stains prior to washing, wait until they have completely evaporated from the fabric before placing garments in the appliance

(*) do not use acetone on artificial silk.

Detergents and additives

Good washing results also depend on the choice of detergent and use of the correct quantities to avoid waste and protect the environment. Although biodegradable, detergents contain substances which, in large quantities, can upset the delicate balance of nature.

The choice of detergent will depend on the type of fabric (delicates, woollens, cottons, etc.), the colour fastness, washing temperature and degree of soiling.

Only low suds frontload washing detergent should be used in this appliance:

- powder detergents for all types of fabric,
- powder detergents for delicate fabrics (60°C max) and woollens,

The detergent and any additives must be placed in the appropriate compartments of the dispenser drawer before starting the wash programme.

If using compact (concentrate) detergents, a programme **without** prewash must be selected.

If a dosage ball/device is supplied with your concentrate detergent, measure the detergent into the device/ball which should then be placed on top of the laundry and at the back of the machine drum.

Any fabric softener or starching additives must be poured into the compartment marked  before starting the wash programme.

Follow the product manufacturer's recommendations on quantities to use and **do not exceed the «MAX» mark in the detergent dispenser drawer.**

Quantity of detergent to be used

The quantity of detergent will depend on the load size, degree of soiling and hardness of the water used.

Water hardness is classified in so-called "degrees" of hardness. Information on hardness of the water in your area can be obtained from the relevant water supply company.

Follow the product manufacturers' instructions on quantities to use.

Not enough washing powder causes:

- the washload to turn gray,
- greasy clothes.

Too much washing powder causes:

- sudsing,
- reduced agitation and washing effect,
- inadequate rinsing,

Use less detergent if:

- you are washing a small load,
- the laundry is lightly soiled,
- large amounts of foam form during washing.

i Operating sequence

Before the first wash we recommend that you pour 2 litres of water into the main wash compartment **U** of the detergent drawer in order to activate the ECO valve. Then run a cotton cycle at 60°C, with the machine empty, in order to remove any manufacturing residue from the drum and tub. Pour half a measure of detergent into the main wash compartment and start up the machine.

1. Place the laundry in the drum

Open the door.

Place the laundry in the drum, one item at a time, shaking them out as much as possible.

Close the door.

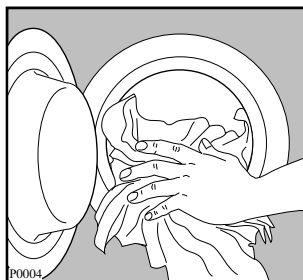

2. Measure out the detergent

Pull out the dispenser drawer until it stops. Measure out the amount of detergent recommended by the manufacturer in a graduated cup and pour it into the main wash compartment **U**.

If you wish to carry out a programme with prewash or a stain phase, pour detergent into the appropriate compartment marked **L**.

Please do not use liquid detergent with this appliance.

3. Measure out the additive

If required, pour fabric softener into the compartment marked **W**, without exceeding the «MAX» mark.

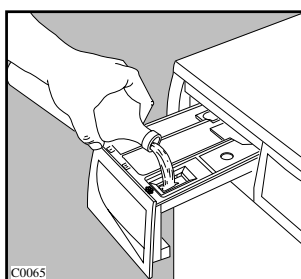
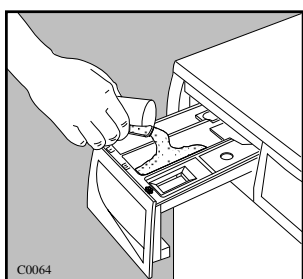

4. Switch the machine on

To switch the machine on, press the ON/OFF button **I**: the mains-on light comes on.

The display will show three blinking dashes or a blinking zero.

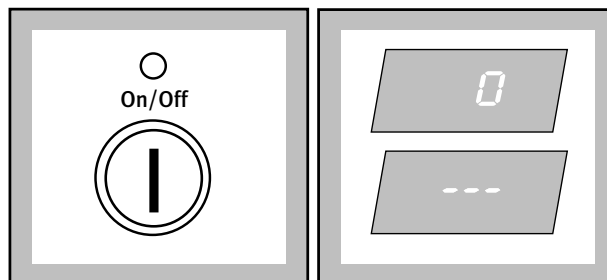

5. Select the desired programme/fabric

Press the FABRICS button repeatedly, in order to select the desired programme/fabric. The relevant light will light up.

The lights relevant to the phases that form the programme will light up.

The display will show the duration of the selected programme, calculated on the basis of the maximum load for each type of fabric. The light of the START/PAUSE button will start flashing.

If the load of laundry to be washed is small, at the beginning of the cycle the display will still indicate the duration relevant to the maximum load. The duration value will be gradually adjusted during the execution of the cycle.

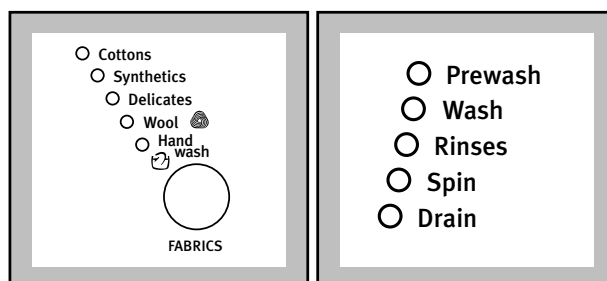

6. Select the temperature

Press the TEMPERATURE button if you wish to select a temperature value different from the one proposed by the washing machine.

The relevant light will light up.

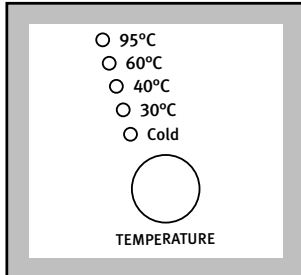

7. Select the SPIN SPEED or the RINSE HOLD option

Press the SPIN SPEED button repeatedly, in order to select the desired spin speed or the RINSE HOLD option. The relevant light will light up.

If you select the RINSE HOLD option, the machine will stop at the end of the programme with the water still in the tub.

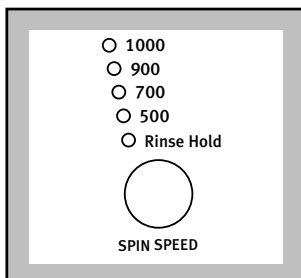

8. Select the desired options

If your laundry is very dirty or has stubborn stains, it may be advisable to select the PREWASH, EXTRA RINSE and/or STAIN option.

Press the OPTIONS button so as to cause the light of the desired option remains lit.

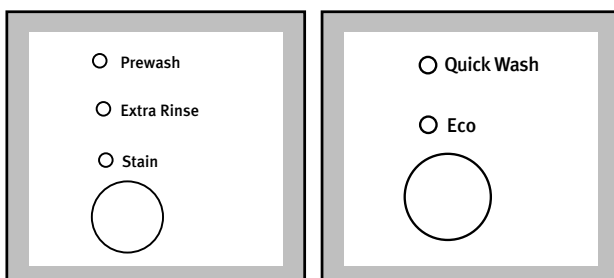

If your laundry is only slightly soiled, depress ECO or QUICK WASH button. The relevant light illuminates.

9. Select the DELAY START

Before you start the programme, if you wish the starting to be delayed, press the DELAY START button repeatedly, or keep it pressed, to select the desired delay. The selected delay time value (up to 23 hours) will appear on the display for 3 seconds, then the duration of the programme will appear again.

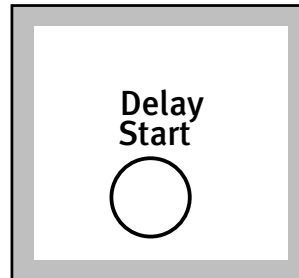

10. Start the programme

Press the START/PAUSE button. The relevant light will stop flashing and only the light relevant to the phase that is in progress will remain lit.

If you have chosen a delayed start, the washing machine will begin the countdown.

The display will show the duration of the programme or the selected delay.

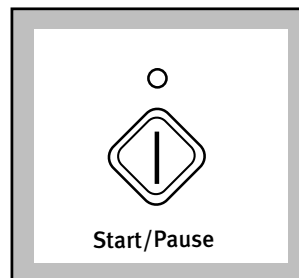

11. How to change a programme during its cycle

Before you make any change, you must pause the washing machine by pressing the START/PAUSE button.

It is possible to change any phase before the programme carries it out.

Changing the type of fabric or temperature is possible, obviously, only during the washing phase.

If it is necessary to drain the water in order to change the programme in progress, proceed as follows:

- PAUSE the machine by pressing the START/PAUSE button;
- press the SKIP RESET button repeatedly, until only the DRAIN light remains lit;
- press the START/PAUSE button again.

When the water has been drained, the display shows a blinking zero. You may now select a new programme and press the START/PAUSE button to start it.

12. How to cancel a programme during its cycle

To cancel a programme that is being carried out, first pause the washing machine by pressing the START/PAUSE button, then press the SKIP RESET button repeatedly, until the display shows **three blinking dashes**.

13. How to open the door during the cycle of a programme

You can open the door, after having set the washing machine to PAUSE, provided the following conditions exist:

- the washing machine is not in the heating phase beyond 55°C;
- the level of the water is not high;
- the drum is not turning.

If these requirements are met, when you pause the washing machine, the door can be opened.

Should it not be possible to open the door, and should it be absolutely necessary to do so, switch the machine off by pressing the ON/OFF button.

After approximately 3 minutes, you can open the door.

Pay attention to the level and temperature of the water in the washing machine!

When you close the door and press the ON/OFF button again, the washing machine will resume the programme from the point where it had been interrupted.

14. End of programme

At the end of the programme, the washing machine stops automatically, and displays a blinking zero.

If you had selected the RINSE HOLD option, the light of the START/PAUSE button goes out, the zero on the display begins to flash, the door is locked and RINSE HOLD light remains lit. To drain and spin see page 8 ("RINSE HOLD position").

When the programme has been completed, a blinking zero appears on the display.

Press the SKIP RESET button repeatedly to erase the programme that has just been carried out. If you omit to do this, the next time you switch the washing machine on, the blinking zero will appear on the display.

Note: when you switch the machine on, if you must erase the previously performed programme, it is also sufficient to press the FABRICS button and select a new programme.

Press the ON/OFF button to switch the machine off. The relevant light will go out.



















Remove the laundry from the washing machine.

Check whether the drum is completely empty, by rotating it with your hand. The purpose of this is to prevent any items of laundry from remaining accidentally in the drum, where they might get damaged in a subsequent wash (e.g. by shrinking) or bleed colour into another load of laundry.

We advise you to close the water supply tap and disconnect the plug from the socket.

Leave the door ajar in order to air the washing machine.

Washing Programmes













Type of laundry and degree of soil	Programme/temperature	Description	Possible options	Dispenser-washing agents
COTTONS Whites and coloureds	Cottons 95°C - 60°C - 40°C -30°C - Cold	Wash at 95°-60°- 40°-30 °C or cold 3 rinses Long spin	SPIN SPEED RINSE HOLD PREWASH EXTRA RINSE STAIN QUICK WASH ECO	 *  
COTTONS Coloureds	Cottons 60°C - 40°C - 30°C - Cold)	Wash at 60° - 40°- 30°C or cold 3 rinses Long spin	SPIN SPEED RINSE HOLD PREWASH EXTRA RINSE STAIN QUICK WASH ECO**	 *  
SYNTHETICS/MIXED FABRICS Whites and coloureds	Synthetics 60°C - - 40°C - 30°C - Cold)	Wash at 60° - 40°- 30°C or cold 3 rinses Short spin	SPIN SPEED RINSE HOLD PREWASH EXTRA RINSE STAIN QUICK WASH ECO**	 *  
DELICATES	Delicates 40°C -30°C -Cold	Wash at 40°-30° C or cold 3 rinses Short spin	SPIN SPEED RINSE HOLD PREWASH EXTRA RINSE QUICK WASH	 *  
Wool Specially tested programme for wool garments bearing the "Pure new wool, non-shrink, machine washable" label.	Wool 40°C -30°C - Cold	Wash at 40°-30° C or cold 3 rinses Short spin	SPIN SPEED RINSE HOLD	 
Handwash Special programme for hand washing fabrics 	Handwash  40°C -30°C - Cold	Wash at 40° - 30-C or cold 3 rinses Long spin	SPIN SPEED RINSE HOLD	 



* With PREWASH option





** Only at 60°-40°C and with 3 Rinses.





i International wash code symbols







These symbols appear on fabric labels, in order to help you choose the best way to treat your laundry.

Energetic wash   Delicate wash	 Max. wash temperature 95°C	 Max. wash temperature 60°C	 Max. wash temperature 40°C	 Max. wash temperature 30°C	 Hand wash	 Do not wash at all
	   					

 Bleaching	 Bleach in cold water	 Do not bleach
---	---	--

 Ironing	 Hot iron max 200°C	 Warm iron max 150°C	 Lukewarm iron max 110°C	 Do not iron
---	--	---	--	--

 Dry cleaning	 Dry cleaning in all solvents	 Dry cleaning in perchlorethylene, petrol, pure alcohol, R 111 & R 113	 Dry cleaning in petrol, pure alcohol and R 113	 Do not dry clean
--	--	---	---	--

 Drying	 Flat	 On the line	 On clothes hanger	 high temperature  low temperature Tumble dry	 Do not tumble dry
--	---	--	---	---	---

Maintenance



Before any maintenance or cleaning is carried out you must **DISCONNECT** the appliance from the electricity supply.

After each wash

Leave the door open for a while. This helps to prevent mould and stagnant smells forming inside the appliance. Keeping the door open after a wash will also help to preserve the door seal.

Maintenance Wash

With the use of low temperature washes it is possible to get a build up of residues inside the drum. We recommend that a maintenance wash be performed on a regular basis.

To run a maintenance wash:

- The drum should be empty of laundry.
- Select the hottest cotton wash programme.
- Use a normal measure of detergent, must be a powder.

Door seal

Check from time to time the door seal and eliminate eventual possible objects that could be trapped in the fold.

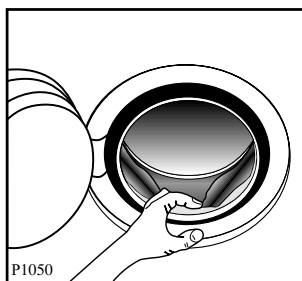

Cabinet

Clean the outside of the machine with warm water and a detergent used to handwash dishes. Rinse with clean water and dry with a soft cloth.

Important: do not use methylated spirits, solvents or similar products to clean the bodywork.

Detergent dispenser drawer

After a while, detergents and fabric softeners leave deposits in the drawer. Inspect the drawer regularly.

To remove the drawer from the machine, press the button in the rear left-hand corner.

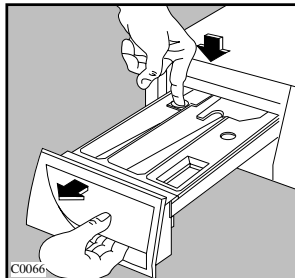

To facilitate cleaning, the top part of the additive compartment can be removed.

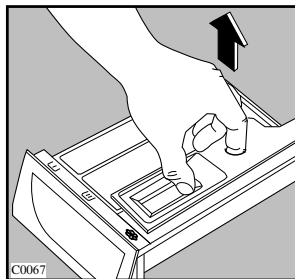

Clean the drawer by rinsing it under a running tap.

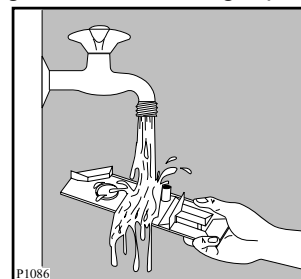
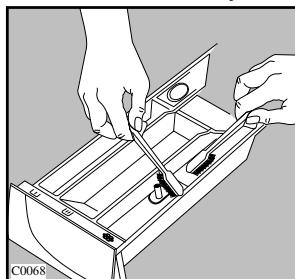

Detergent can also accumulate inside the drawer recess: clean it with an old toothbrush. Refit the drawer after cleaning.

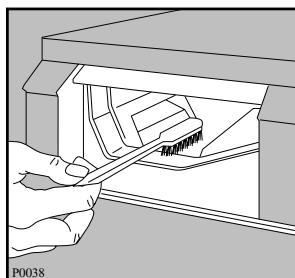

Drain pump

The pump should be inspected if

- the machine does not empty and/or spin
- the machine makes an unusual noise during draining due to objects such as safety pins, coins etc. blocking the pump.

Proceed as follows:

- Disconnect the appliance.
- If necessary wait until the water has cooled down.
- Open the pump door.

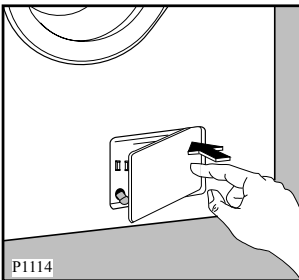

- Place a container close to the pump to collect any spillage.
- Release the emergency emptying hose, place it in the container and remove its cap.
- When no more water comes out, unscrew the pump guard and remove it. Always keep a rag nearby to dry up spillage of water when removing the pump guard.

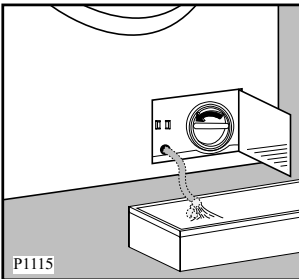

- Remove any objects from the pump impeller by rotating it.

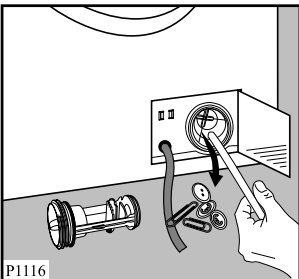

- Put the cap back on the emergency emptying hose and place the latter back in its seat.

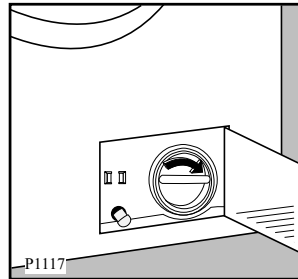

- Screw the pump guard fully in.
- Close the pump door.

Water inlet filter

If you notice that the machine is taking longer to fill, check that the filter in the water inlet hose is not blocked.

Turn off the water tap.

Unscrew the hose from the tap.

Clean the filter with a stiff brush.

Screw the hose back onto the tap.

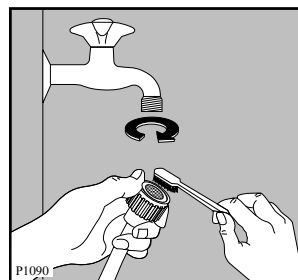

Emergency emptying out

If the water is not discharged, proceed as follows to empty out the machine:

- pull out the plug from the power socket;
- close the water tap;
- if necessary, wait until the water has cooled down;
- open the pump door;
- place a bowl on the floor and place the end of the emergency emptying hose into the bowl. Remove its cap. The water should drain by gravity into the bowl. When the bowl is full, put the cap back on the hose. Empty the bowl. Repeat the procedure until water stops flowing out;
- clean the pump guard if necessary as previously described;
- replace the emergency emptying hose in its seat after having plugged it;
- screw the drain filter fully in again and close the door.

The dangers of freezing

If the machine is installed in a place where the temperature could drop below 0°C, proceed as follows:

- Remove the plug from the socket.
- Close the water tap and unscrew the water inlet hose from the tap.
- Place the end of the emergency emptying hose and that of the inlet hose in a bowl placed on the floor and let water drain out.
- Screw the water inlet hose back on and reposition the emergency emptying hose after having put the cap on again.

By doing this, any water remaining in the machine is removed, avoiding the formation of ice and, consequently, breakage of the affected parts.

When you use the machine again, make sure that the ambient temperature is above 0°C.

Important!

Every time you drain the water through the emergency emptying hose you must pour 2 litres of water into the main wash compartment of the detergent drawer and then run the drain programme. This will activate the ECO valve avoiding that part of the detergent remains unused at next washing.

Trouble-Shooting Guide

Certain problems are due to lack of simple maintenance or oversights, which can be solved easily without calling out a service technician. Before contacting your local Service Centre, please carry out the checks listed below.

During machine's operation it is possible that one of the following alarm codes will appear on the display, then a warning signal will be heard.

- **E10** = there is no water filling
- **E20** = the water is not drained
- **E40** = door open

Once the problem has been eliminated, press the START PAUSE button  to restart the programme. If after all checks, the problem persists, contact your local Service Centre.

Problem	Possible cause
<ul style="list-style-type: none"> • The machine does not start up: 	<ul style="list-style-type: none"> • The door is not firmly closed. (E40) • The machine is not plugged in or there is no power at the socket. • The main fuse or the fuse in the plug has blown. • The START PAUSE button has not been depressed. • The DELAY START option has been selected.
<ul style="list-style-type: none"> • The machine does not fill: 	<ul style="list-style-type: none"> • The water tap is closed. (E10) • The inlet hose is squashed or kinked. (E10) • The filter in the inlet hose is blocked. (E10) • The door is not properly closed. (E40)
<ul style="list-style-type: none"> • The machine fills then empties immediately: 	<ul style="list-style-type: none"> • The end of the drain hose is too low. Refer to relevant paragraph in "water drainage" section.
<ul style="list-style-type: none"> • The machine does not empty and/or does not spin: 	<ul style="list-style-type: none"> • The drain hose is squashed or kinked. (E20) • The RINSE HOLD option has been selected. • The drain pump is clogged. (E20)
<ul style="list-style-type: none"> • There is water on the floor: 	<ul style="list-style-type: none"> • Too much detergent or unsuitable detergent (creates too much foam) has been used. • Check whether there are any leaks from one of the inlet hose fittings. It is not always easy to see this as the water runs down the hose; check to see if it is damp. • The drain hose is damaged. • The pump guard has not been fully screwed in. • The cap on the emergency emptying hose has not been replaced after cleaning the pump.
<ul style="list-style-type: none"> • Unsatisfactory washing results: 	<ul style="list-style-type: none"> • Too little detergent or unsuitable detergent has been used. • Stubborn stains have not been treated prior to washing. • The correct programme / temperature was not selected. • Excessive laundry load.
<ul style="list-style-type: none"> • The machine vibrates or is noisy: 	<ul style="list-style-type: none"> • The transit bolts and packing have not been removed. • The support feet have not been adjusted. • The laundry is not evenly distributed in the drum. • Maybe there is very little laundry in the drum.

Problem	Possible cause
<ul style="list-style-type: none"> • The door will not open: 	<ul style="list-style-type: none"> • The programme is still running, the drum is turning. • The door lock has not yet released. • The water level is above the bottom edge of the door. • The machine is heating the water.
<ul style="list-style-type: none"> • Spinning starts late or the laundry is not spun enough: 	<ul style="list-style-type: none"> • The electronic unbalance detection device has cut in because the laundry is not evenly distributed in the drum. The laundry is redistributed by reverse rotation of the drum. This may happen several times before the unbalance disappears and normal spinning can resume. If, after few minutes, the laundry is still not evenly distributed in the drum, the machine will spin at a lower speed or will not spin. If at the end of the programme the laundry is not spun enough, redistribute the load manually and select the spin programme.
<ul style="list-style-type: none"> • No water is visible in the drum 	<ul style="list-style-type: none"> • Machines based on modern technology operate very economically using very little water without affecting performance.
<ul style="list-style-type: none"> • The machine makes an unusual noise 	<ul style="list-style-type: none"> • The machine is fitted with a type of motor which makes an unusual noise compared with other traditional motors. This new motor ensures a softer start and more even distribution of the laundry in the drum when spinning, as well as increased stability of the machine.

If you are unable to identify or solve the problem, contact your nearest service centre. Before telephoning, make a note of the model, serial number and purchase date of your machine: the Service Centre will require this information.

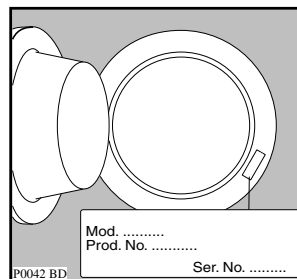

Electrolux Warranty

FOR SALES IN AUSTRALIA AND NEW ZEALAND
APPLIANCE: [FRONT LOAD WASHER]

This document sets out the terms and conditions of product warranties for Electrolux branded appliances. It is an important document. Please keep it with your proof of purchase documents in a safe place for future reference should you require service for your Electrolux appliance.

General Terms and Conditions

- In this warranty
 - 'Electrolux' means Electrolux Home Products Pty Ltd ABN 51 004 762 341 in respect of Appliances purchased in Australia and Electrolux (NZ) Limited in respect of Appliances purchased in New Zealand;
 - 'Appliance' means any Electrolux product purchased by you accompanied by this document;
 - 'Warranty Period' means
 - where you use the Appliance for personal, domestic or household purposes in Australia the period of 24 months and in New Zealand the period of 24 months;
 - where you use the Appliance for commercial purposes, in Australia the period of 3 months and in New Zealand the period of 3 months, (if the period stated is 0 months you are not covered by this product warranty) following the date of original purchase of the Appliance;
 - 'you' means the purchaser of the Appliance not having purchased the appliance for re-sale, and 'your' has a corresponding meaning.
- This warranty only applies to Appliances purchased and used in Australia or New Zealand and is in addition to (and does not exclude, restrict, or modify in any way) any non-excludable statutory warranties in Australia or New Zealand.
- Electrolux warrants that, when dispatched from an Electrolux warehouse, the Appliance is free from defects in materials and workmanship for the Warranty Period.
- During the Warranty Period Electrolux or its Authorised Service Centre will, at no extra charge if your appliance is readily accessible without special equipment, and subject to these terms and conditions, repair or replace any parts which it considers to be defective. You agree that any replaced Appliances or parts become the property of Electrolux. This warranty does not apply to light globes, batteries, filters or similar perishable parts.
- Parts and Appliances not supplied by Electrolux are not covered by this warranty.
- Where you are within an Electrolux service area, this warranty covers the cost of transport of the Appliance to and from Authorised Service Centres of Electrolux and travelling costs for representatives of the Authorised Service Centre to and from your home or business. If you are outside an Electrolux service area, you will bear these costs. For information about whether you are within an Electrolux service area, please phone 13 13 49 in Australia, or 0800 10 66 10 in New Zealand.
- Proof of purchase is required before you can make a claim under this warranty.

- You may not make a claim under this warranty unless the defect claimed is due to faulty or defective parts or workmanship. Electrolux is not liable in the following situations (which are not exhaustive):
 - The Appliance is damaged by:
 - accident
 - misuse or abuse, including failure to properly maintain or service
 - normal wear and tear
 - power surges, electrical storm damage or incorrect power supply
 - incomplete or improper installation
 - incorrect, improper or inappropriate operation
 - insect or vermin infestation.
 - The Appliance is modified without authority from Electrolux in writing.
 - The Appliance's serial number or warranty seal has been removed or defaced.
 - The Appliance was serviced or repaired by anyone other than Electrolux or its Authorised Service Centres.

- This warranty, the contract to which it relates and the relationship between you and Electrolux are governed by the law applicable in the Australian State where the Appliance was purchased or the law applicable in New Zealand if the Appliance was purchased in New Zealand. Where the Appliance was purchased in New Zealand for business purposes the Consumer Guarantee Act does not apply.

Limitation of Liability

- To the extent permitted by law:
 - Electrolux excludes all warranties other than as contained in this document;
 - Electrolux shall not be liable for any loss or damage whether direct or indirect or consequential arising from your purchase, use or non-use of the Appliance.
- Provisions of the Trade Practices Act and State consumer legislation in Australia, and the Consumer Guarantees Act, the Sale of Goods Act and the Fair Trading Act in New Zealand, imply warranties or conditions, or impose obligations, upon Electrolux which cannot be excluded, restricted or modified. To the extent permitted by law, the liability of Electrolux (if any) arising out of or in relation to the Appliance or any services supplied by Electrolux shall be limited (where it is fair and reasonable to do so):
 - in the case of Appliances, at its option, to the replacement or repair of the Appliances or the supply of equivalent products or the payment of the cost of replacing the Appliances or having the Appliances repaired or of acquiring equivalent Appliances. Upon being replaced, parts and Appliances become the property of Electrolux; or
 - in the case of services, at its option, to the supply of the services again or the payment of the cost of having the services re-supplied;
 and in the case of Appliances or services supplied in New Zealand, loss or damage whether direct or indirect or consequential that is reasonably foreseeable.

Privacy

You acknowledge that in the event that you make a warranty claim it will be necessary for Electrolux and its Authorised Service Centres to exchange information in relation to you to enable Electrolux to meet its obligations under this warranty.

Important Notice

Before Calling a Service Technician please check carefully the operating instructions, service booklet and the warranty terms and conditions.

<p>FOR SERVICE OR TO FIND THE ADDRESS OF YOUR NEAREST STATE SERVICE CENTRE IN AUSTRALIA Please call 13 13 49 For the cost of a local call (Australia only)</p>	<p>SERVICE AUSTRALIA  ELECTROLUX HOME PRODUCTS</p>	<p>FOR SPARE PARTS OR TO FIND THE ADDRESS OF YOUR NEAREST STATE SPARE PARTS CENTRE IN AUSTRALIA Please call 13 13 50 For the cost of a local call (Australia only)</p>
<p>FOR SERVICE OR TO FIND THE ADDRESS OF YOUR NEAREST AUTHORISED SERVICE CENTRE IN NEW ZEALAND Free call 0800 10 66 10 (New Zealand only)</p>	<p>NEW ZEALAND SPARE PARTS CENTRES AUCKLAND Prime Distributors Ltd. 8 Highbrook Drive, East Tamaki.....(09) 273 3580 WELLINGTON Prime Distributors Ltd. 68 Victoria Street, Petone.....(04) 586 2150 CHRISTCHURCH Prime Distributors Ltd. Unit 1, 127 Montreal Street.....(03) 377 1009 R. Redpath Ltd. 55 Ferry Road.....(03) 379 0446 DUNEDIN South City Champion, 590 Hillside Road.....(03) 455 5443  ELECTROLUX HOME PRODUCTS</p>	

Electrolux

 **The Electrolux Group.** *The world's No. 1 choice.*

The Electrolux Group is the world's largest producer of powered appliances for kitchen, cleaning and outdoor use. More than 55 million Electrolux Group products (such as refrigerators, cookers, washing machines, vacuum cleaners, chain saws and lawn mowers) are sold each year to a value of approx. USD 14 billion in more than 150 countries around the world.